

# SIEMENS

## SIMATIC HMI

### HMI devices Basic Panels

#### Operating Instructions

Preface

---

Overview

---

1

Safety instructions

---

2

Mounting and connecting

---

3

Operating the device

---

4

Configuring the HMI device

---

5

Commissioning a project

---

6

Maintenance and care

---

7

Technical specifications

---

8

Technical Support

---

A

Abbreviations

---

B

## Legal information

### Warning notice system

This manual contains notices you have to observe in order to ensure your personal safety, as well as to prevent damage to property. The notices referring to your personal safety are highlighted in the manual by a safety alert symbol, notices referring only to property damage have no safety alert symbol. These notices shown below are graded according to the degree of danger.

<b>⚠ DANGER</b>
indicates that death or severe personal injury <b>will</b> result if proper precautions are not taken.
<b>⚠ WARNING</b>
indicates that death or severe personal injury <b>may</b> result if proper precautions are not taken.
<b>⚠ CAUTION</b>
with a safety alert symbol, indicates that minor personal injury can result if proper precautions are not taken.
<b>CAUTION</b>
without a safety alert symbol, indicates that property damage can result if proper precautions are not taken.
<b>NOTICE</b>
indicates that an unintended result or situation can occur if the relevant information is not taken into account.

If more than one degree of danger is present, the warning notice representing the highest degree of danger will be used. A notice warning of injury to persons with a safety alert symbol may also include a warning relating to property damage.

### Qualified Personnel

The product/system described in this documentation may be operated only by **personnel qualified** for the specific task in accordance with the relevant documentation, in particular its warning notices and safety instructions. Qualified personnel are those who, based on their training and experience, are capable of identifying risks and avoiding potential hazards when working with these products/systems.

### Proper use of Siemens products

Note the following:

<b>⚠ WARNING</b>
Siemens products may only be used for the applications described in the catalog and in the relevant technical documentation. If products and components from other manufacturers are used, these must be recommended or approved by Siemens. Proper transport, storage, installation, assembly, commissioning, operation and maintenance are required to ensure that the products operate safely and without any problems. The permissible ambient conditions must be complied with. The information in the relevant documentation must be observed.

### Trademarks

All names identified by ® are registered trademarks of Siemens AG. The remaining trademarks in this publication may be trademarks whose use by third parties for their own purposes could violate the rights of the owner.

### Disclaimer of Liability

We have reviewed the contents of this publication to ensure consistency with the hardware and software described. Since variance cannot be precluded entirely, we cannot guarantee full consistency. However, the information in this publication is reviewed regularly and any necessary corrections are included in subsequent editions.

# Preface

## Purpose of the operating instructions

These operating instructions provide information based on the requirements defined by IEC 62079 for documentation. This information relates to the HMI device, its storage, transportation, place of use, installation, use and maintenance.

These operating instructions are intended for a variety of target groups. The following table shows the chapters of these operating instructions that are of particular importance for the respective target group.

Target group	Chapter
<b>All</b>	"Safety instructions"
<b>Operators</b> The operator operates and monitors the system during the process control phase.	"Overview" "Operating a project"
<b>Commissioning engineers</b> The commissioning engineer integrates the HMI device into the system and ensures the operating capability of the HMI device for the process control phase.	All chapters. Depending on the use of the HMI device, certain chapters may not be of relevance to the commissioning engineer, e.g. the section "Maintenance and servicing."
<b>Service technicians</b> Service technicians rectify faults that occur during the process control phase.	All chapters. Depending on the use of the HMI device, certain chapters may not be of relevance to the service technicians, e.g. the section "Maintenance and servicing."
<b>Maintenance technicians</b> Maintenance technicians carry out servicing and maintenance work during the process control phase.	Maintenance and care

The information system of WinCC flexible and WinCC contains further additional information. The information system is integrated as online help in WinCC flexible and WinCC and contains instructions, examples and reference information in electronic form.

## Scope

These operating instructions are valid for all SIMATIC HMI Basic Panels. The following naming conventions apply:

Device designation	Device type	Interface type	Can be configured with	
<b>SIMATIC HMI</b>				
KP300 Basic mono PN	Keyboard unit	Basic Panel PN	WinCC (TIA Portal) as of V11	
KP400 Basic color PN			WinCC (TIA Portal) as of V11 SP2 Update 2 with HSP Basic 4" color	
KTP400 Basic mono PN	Touch device with function keys		WinCC flexible and WinCC (TIA Portal) as of V11	
KTP400 Basic color PN			WinCC (TIA Portal) as of V11 SP2 Update 2 with HSP Basic 4" color	
KTP600 Basic mono PN			WinCC flexible and WinCC (TIA Portal) as of V11	
KTP600 Basic color DP				Basic Panel DP
KTP600 Basic color PN				Basic Panel PN
KTP1000 Basic color DP				Basic Panel DP
KTP1000 Basic color PN			Basic Panel PN	
TP1500 Basic color PN			Touch device	

In addition, the following collective designations are also used in these operating instructions:

Designation	Covers the HMI devices
KTP400 Basic	KTP400 Basic mono PN, KTP400 Basic color PN
KTP600 Basic	KTP600 Basic mono PN, KTP600 Basic color DP, KTP600 Basic color PN
KTP1000	KTP1000 Basic color DP, KTP1000 Basic color PN

## Basic knowledge required

Knowledge of automation technology and process communication is necessary to understand the operating instructions.

An understanding of the use of computers and operating systems is also required.

## Illustrations and text highlighting

This manual contains illustrations of the described devices. The illustrations may deviate from the supplied device in certain details.

The following graphical highlighting facilitates reading these operating instructions:

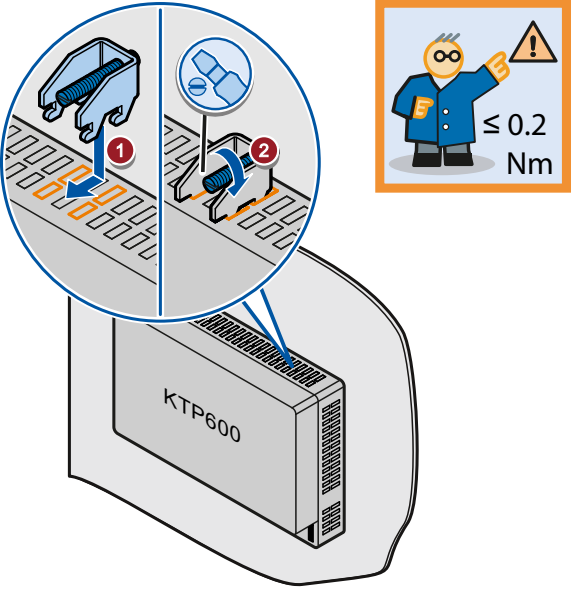
Graphical highlighting	Description
	<p>If the instructions involve several tasks, the individual tasks are highlighted by a red number circle.</p> <p>A light blue highlight indicates components and tools that are required in the course of a task.</p> <p>Safety instructions are highlighted by an orange frame.</p> <p>KTP600 Basic is sometimes shown in the illustrations as a representation of all Basic Panels.</p>

The following text highlighting facilitates reading these operating instructions:

Text highlighting	Scope
"Add screen"	<ul style="list-style-type: none"> <li>• Terms that appear in the user interface, for example, dialog names, tabs, buttons, menu commands</li> <li>• Input values, for example, limits, tag values</li> <li>• Path information</li> </ul>
"File > Edit"	Operational sequences, for example, menu commands, shortcut menu commands
<F1>	Keyboard operation

Configuration and runtime software have different names as follows:

- "WinCC flexible 2008" or "WinCC (TIA Portal) V11", for example, refers to the configuration software.

The term "WinCC flexible" or "WinCC" is used in a general context. The full name, for example, "WinCC flexible 2008", is always used when it is necessary to differentiate between different versions of the configuration software.

- "WinCC flexible Runtime" or "WinCC Runtime" refers to the runtime software that can run on HMI devices.

Note information highlighted as follows:

---

**Note**

A note contains important information on described products and their handling or on a section of this documentation.

---

## Trademarks

Names labeled with a ® symbol are registered trademarks of the Siemens AG. Other names used in this documentation may be trademarks, the use of which by third parties for their own purposes could violate the rights of the owner.

- HMI®
- SIMATIC®
- SIMATIC HMI®
- WinCC®

# Table of contents

	<b>Preface .....</b>	<b>3</b>
<b>1</b>	<b>Overview.....</b>	<b>11</b>
1.1	Product Overview.....	11
1.2	Design of the KP300 Basic mono PN .....	12
1.3	Design of the KP400 Basic color PN .....	13
1.4	Design of the KTP400 Basic mono PN.....	15
1.5	Design of the KTP400 Basic color PN .....	16
1.6	Design of the KTP600 Basic mono/color PN .....	17
1.7	Design of the KTP600 Basic color DP .....	18
1.8	Design of the KTP1000 Basic color PN .....	19
1.9	Design of the KTP1000 Basic color DP .....	20
1.10	Design of the TP1500 Basic color PN .....	21
1.11	Product package .....	22
1.12	Accessories.....	23
1.13	Commissioning the HMI device .....	24
<b>2</b>	<b>Safety instructions .....</b>	<b>25</b>
2.1	General safety instructions .....	25
2.2	Security information .....	26
2.3	Notes about usage.....	26
<b>3</b>	<b>Mounting and connecting.....</b>	<b>29</b>
3.1	Preparations.....	29
3.1.1	Checking the package contents.....	29
3.1.2	Checking the operating conditions.....	29
3.1.3	Selecting a mounting position.....	29
3.1.4	Checking clearances.....	31
3.1.5	Making the mounting cut-out.....	31
3.1.6	Labeling the function keys .....	33
3.2	Mounting the HMI device .....	34
3.3	Connecting the HMI device.....	36
3.3.1	Connection sequence .....	36
3.3.2	Connecting the equipotential bonding circuit.....	38
3.3.3	Connecting the power supply.....	39
3.3.4	Connecting a programming device .....	41
3.3.5	Connecting the configuration PC .....	42
3.3.6	Connecting the PLC.....	45

3.4	Switching on and testing the HMI device .....	48
3.5	Securing the cables.....	50
<b>4</b>	<b>Operating the device.....</b>	<b>51</b>
4.1	Operating touch devices .....	51
4.1.1	Overview .....	51
4.1.2	General functions of the screen keyboard .....	53
4.1.3	Entering data on the KTP400 Basic.....	54
4.1.4	Entering data on the KTP600 Basic, KTP1000 Basic , TP1500 Basic .....	57
4.2	Operating KP300 Basic.....	59
4.2.1	Overview .....	59
4.2.2	Entering data on the KP300 Basic .....	60
4.3	Operating KP400 Basic.....	63
4.3.1	Overview .....	63
4.3.2	Entering data on the KP400 Basic .....	66
<b>5</b>	<b>Configuring the HMI device.....</b>	<b>67</b>
5.1	Configuring devices with graphical Control Panel .....	67
5.1.1	Opening the Control Panel.....	67
5.1.2	Overview .....	68
5.1.3	Changing MPI/DP settings .....	69
5.1.4	Changing the network configuration .....	70
5.1.5	Time server configuration.....	71
5.1.6	Changing monitor settings .....	72
5.1.7	Displaying information about the HMI device.....	73
5.1.8	Calibrating the touch screen .....	74
5.1.9	Displaying licensing information for the HMI device .....	75
5.1.10	Enabling a data channel.....	76
5.1.11	Changing password settings .....	78
5.1.12	Setting the Screen Saver .....	79
5.1.13	Setting acoustic signals.....	79
5.2	Configuring KP300 Basic .....	80
5.2.1	Opening the Control Panel.....	80
5.2.2	Overview .....	81
5.2.3	Displaying information about the HMI device.....	83
5.2.4	Changing monitor settings .....	83
5.2.5	Enabling a data channel.....	84
5.2.6	Changing the network configuration .....	85
5.2.7	Time server configuration.....	86
5.2.8	Changing password settings .....	87
5.2.9	Setting the Screen Saver .....	88
<b>6</b>	<b>Commissioning a project.....</b>	<b>89</b>
6.1	Overview .....	89
6.2	Operating modes.....	90
6.3	Data transmission options.....	91



6.4	Transfer.....	91
6.4.1	Overview.....	91
6.4.2	Starting manual transfer.....	91
6.4.3	Starting automatic transfer.....	93
6.4.4	Testing a project.....	95
6.5	Backup and restore.....	96
6.5.1	Overview.....	96
6.5.2	Backup and restore using WinCC flexible.....	97
6.5.3	Backup and restore using ProSave.....	99
6.5.4	Backup and restore using WinCC.....	100
6.6	OS update - Basic Panel DP.....	101
6.6.1	Overview.....	101
6.6.2	Resetting factory settings.....	102
6.6.3	Updating the Operating System using WinCC flexible.....	102
6.6.4	Updating the Operating System using ProSave.....	104
6.7	OS update - Basic Panel PN.....	105
6.7.1	Overview.....	105
6.7.2	Resetting factory settings.....	106
6.7.3	Updating the operating system using WinCC flexible.....	106
6.7.4	Updating the operating system using ProSave.....	108
6.7.5	Updating the operating system using WinCC.....	109
6.7.6	Resetting to factory settings with WinCC flexible.....	110
6.7.7	Resetting to factory settings with ProSave.....	112
6.7.8	Resetting to factory settings with WinCC.....	114
<b>7</b>	<b>Maintenance and care.....</b>	<b>115</b>
7.1	Maintenance and care.....	115
7.2	Recycling.....	116
<b>8</b>	<b>Technical specifications.....</b>	<b>117</b>
8.1	Certificates and approvals.....	117
8.2	Directives and declarations.....	118
8.2.1	Electromagnetic compatibility.....	118
8.2.2	ESD guideline.....	119
8.3	Dimension drawings.....	122
8.3.1	Dimension drawing of the KP300 Basic mono PN.....	122
8.3.2	Dimension drawing of the KP400 Basic color PN.....	123
8.3.3	Dimension drawing of the KTP400 Basic mono PN.....	124
8.3.4	Dimension drawing of the KTP400 Basic color PN.....	125
8.3.5	Dimension drawing of the KTP600 Basic color DP.....	126
8.3.6	Dimension drawing of the KTP600 Basic mono/color PN.....	127
8.3.7	Dimension drawing of the KTP1000 Basic color DP.....	128
8.3.8	Dimension drawing of the KTP1000 Basic color PN.....	129
8.3.9	Dimension drawing of the TP1500 Basic color PN.....	130

8.4	Specifications .....	131
8.4.1	Power supply.....	131
8.4.2	KP300 Basic and KP400 Basic.....	131
8.4.3	KTP400 Basic and KTP600 Basic .....	133
8.4.4	KTP1000 Basic and TP1500 Basic.....	135
8.4.5	Ambient conditions.....	137
8.4.5.1	Transport and storage conditions .....	137
8.4.5.2	Conditions of use .....	138
8.4.5.3	Information on insulation tests, protection class and degree of protection.....	140
8.5	Interface description.....	141
8.5.1	Power supply.....	141
8.5.2	PROFIBUS (Sub-D RS422/485) .....	141
8.5.3	PROFINET (Ethernet).....	142
8.6	Functional scope with WinCC flexible and WinCC .....	143
<b>A</b>	<b>Technical Support.....</b>	<b>147</b>
A.1	Service and support .....	147
A.2	System events.....	148
<b>B</b>	<b>Abbreviations .....</b>	<b>149</b>
	<b>Glossary .....</b>	<b>151</b>
	<b>Index.....</b>	<b>157</b>

# Overview

## 1.1 Product Overview

### Concentrating on the essentials - the new Basic Panels

Today, visualization is part of the standard repertoire for most machines. The cost factor plays a crucial role in this case, especially for small machines and simple applications. HMI devices with basic functions are often fully sufficient for simple applications.

This is exactly the demand that we intend to meet – with our new SIMATIC HMI Basic Panels. By concentrating on the essentials, the Basic Panels offer exactly those basic features that are demanded – at the right price. A perfect cost-to-performance ratio.

Like all devices in our product catalog, the new Basic Panels offer proven SIMATIC quality and – regardless of their display dimensions – many software functions as standard: for example, an alarm system, recipe management, trend functionality and language switching. Users therefore profit from the advantages of visualization, such as improved process quality, even with simple applications.

## 1.2 Design of the KP300 Basic mono PN

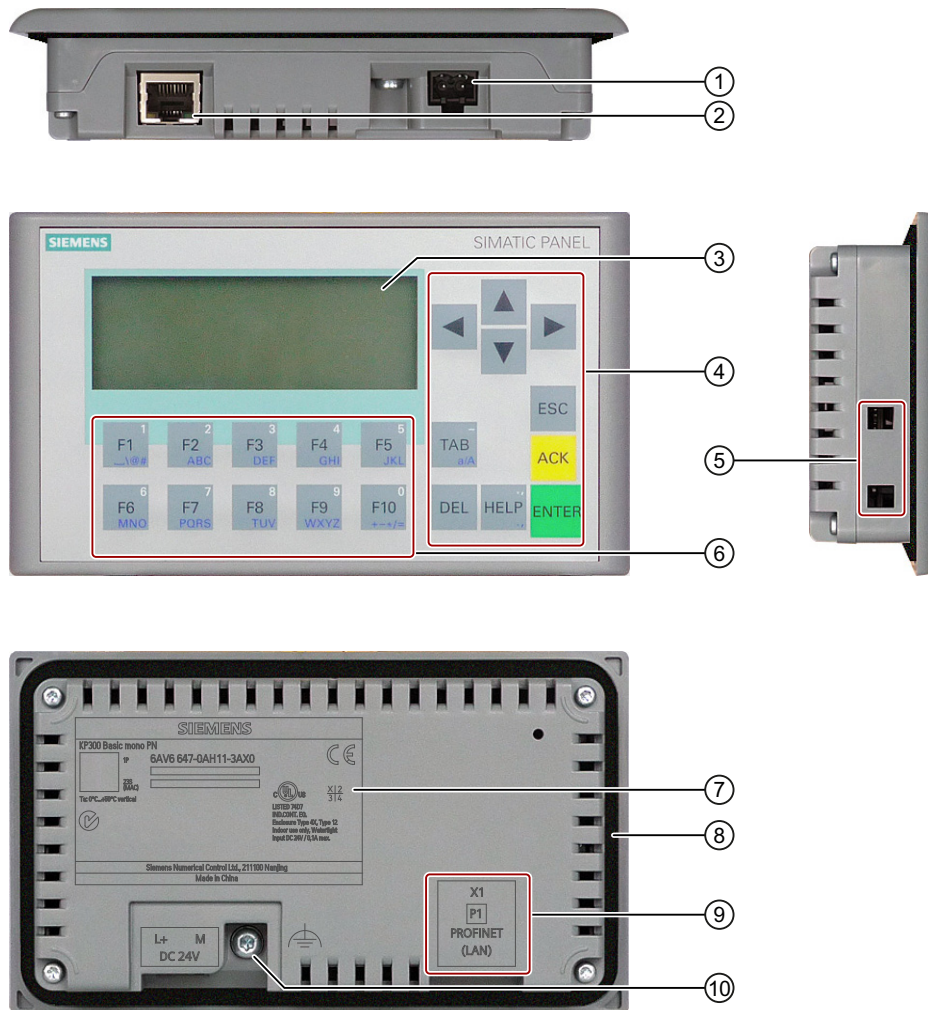

- |                                |                               |
|--------------------------------|-------------------------------|
| ① Power supply connector       | ⑥ Function keys               |
| ② PROFINET interface           | ⑦ Rating plate                |
| ③ Display                      | ⑧ Mounting seal               |
| ④ Control keys                 | ⑨ Interface name              |
| ⑤ Cutouts for a mounting clamp | ⑩ Functional earth connection |

### 1.3 Design of the KP400 Basic color PN

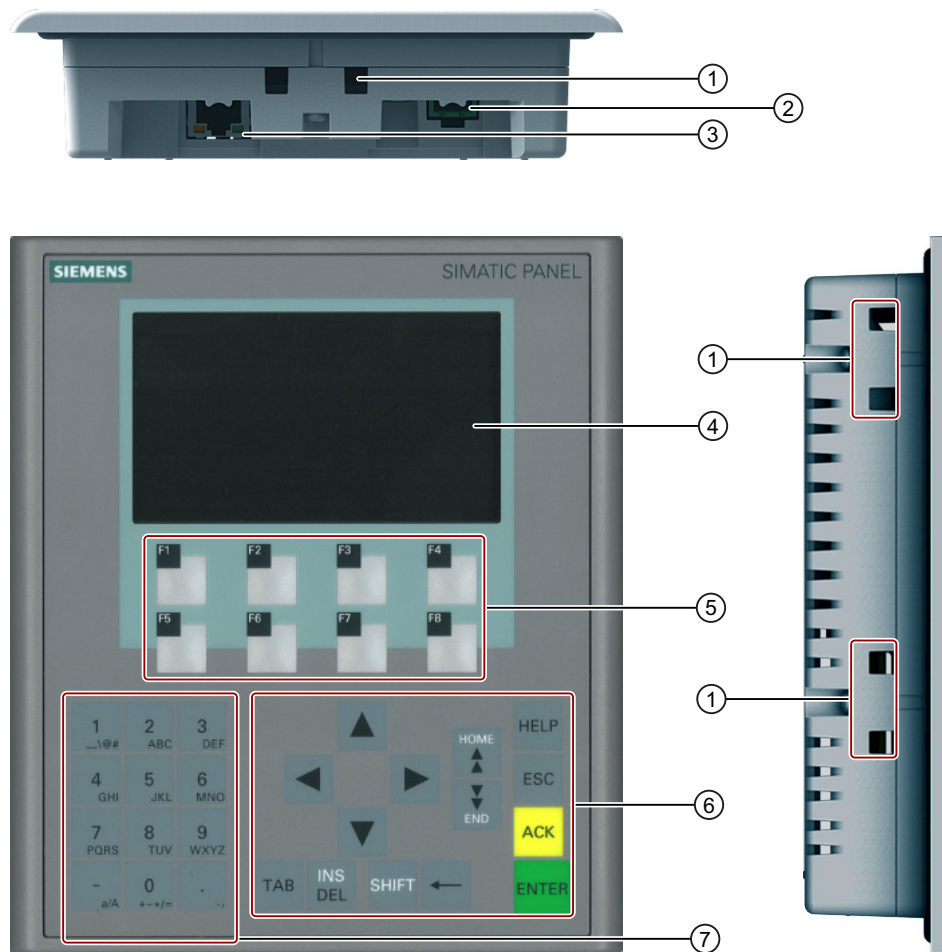

- |                               |                   |
|-------------------------------|-------------------|
| ① Cutouts for mounting clamps | ⑤ Function keys   |
| ② Power supply connector      | ⑥ Control keys    |
| ③ PROFINET interface          | ⑦ Data input keys |
| ④ Display                     |                   |

1.3 Design of the KP400 Basic color PN

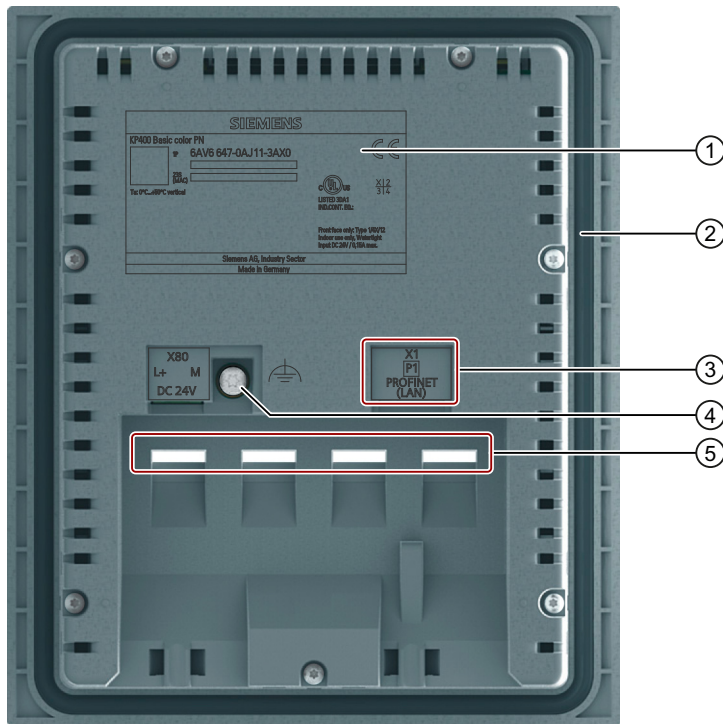

- ① Rating plate
- ② Mounting seal
- ③ Interface name
- ④ Functional earth connection
- ⑤ Guides for labeling strips

## 1.4 Design of the KTP400 Basic mono PN

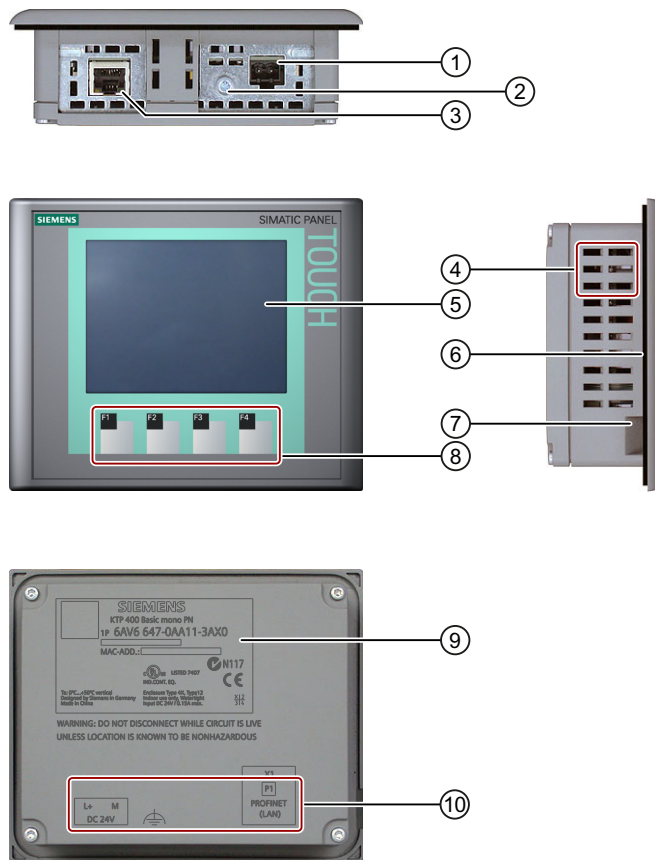

- |                                |                              |
|--------------------------------|------------------------------|
| ① Power supply connector       | ⑥ Mounting seal              |
| ② Functional earth connection  | ⑦ Guide for a labeling strip |
| ③ PROFINET interface           | ⑧ Function keys              |
| ④ Cutouts for a mounting clamp | ⑨ Rating plate               |
| ⑤ Display/touch screen         | ⑩ Interface name             |

## 1.5 Design of the KTP400 Basic color PN

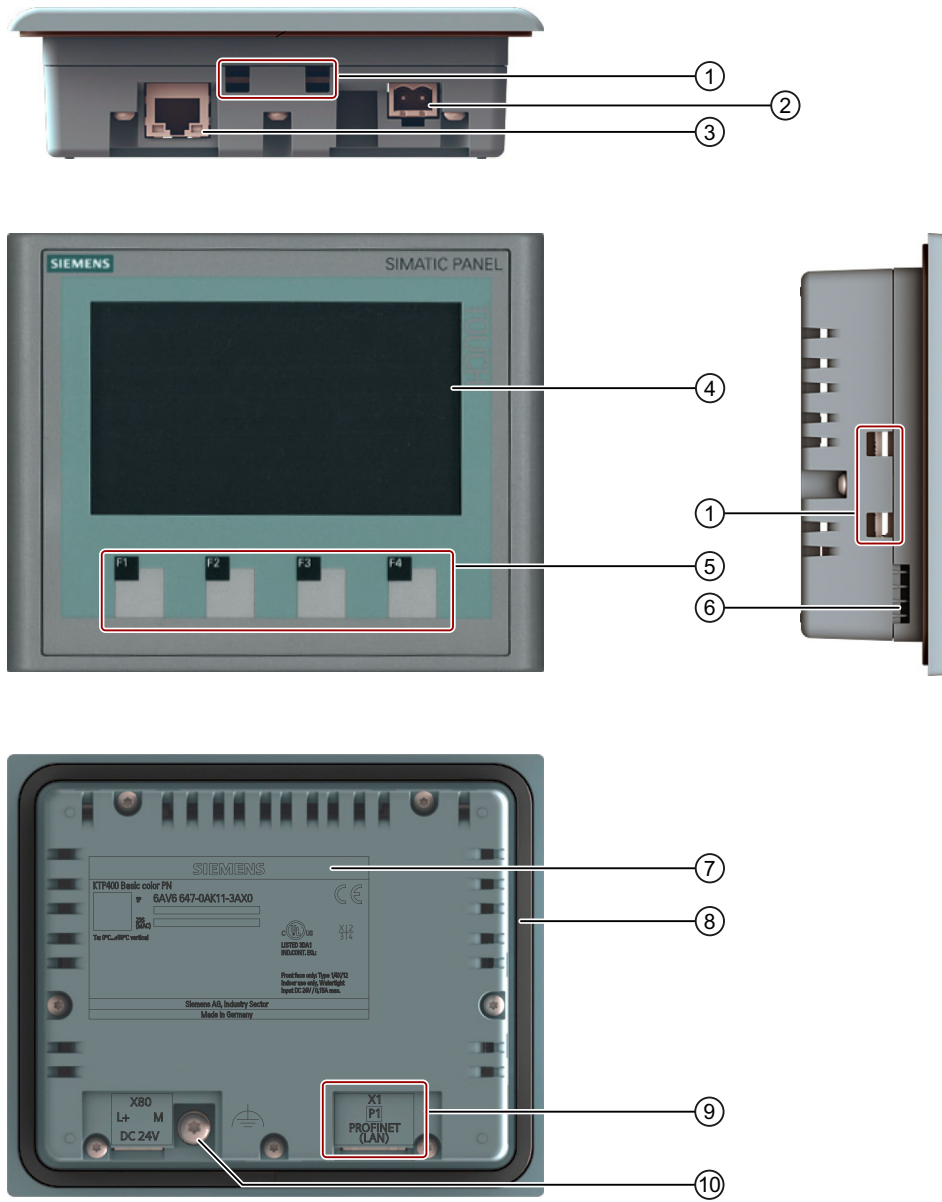

- |   |                             |   |                             |
|---|-----------------------------|---|-----------------------------|
| ① | Cutouts for mounting clamps | ⑥ | Guide for a labeling strip  |
| ② | Power supply connector      | ⑦ | Rating plate                |
| ③ | PROFINET interface          | ⑧ | Mounting seal               |
| ④ | Display/touch screen        | ⑨ | Interface name              |
| ⑤ | Function keys               | ⑩ | Functional earth connection |



## 1.6 Design of the KTP600 Basic mono/color PN

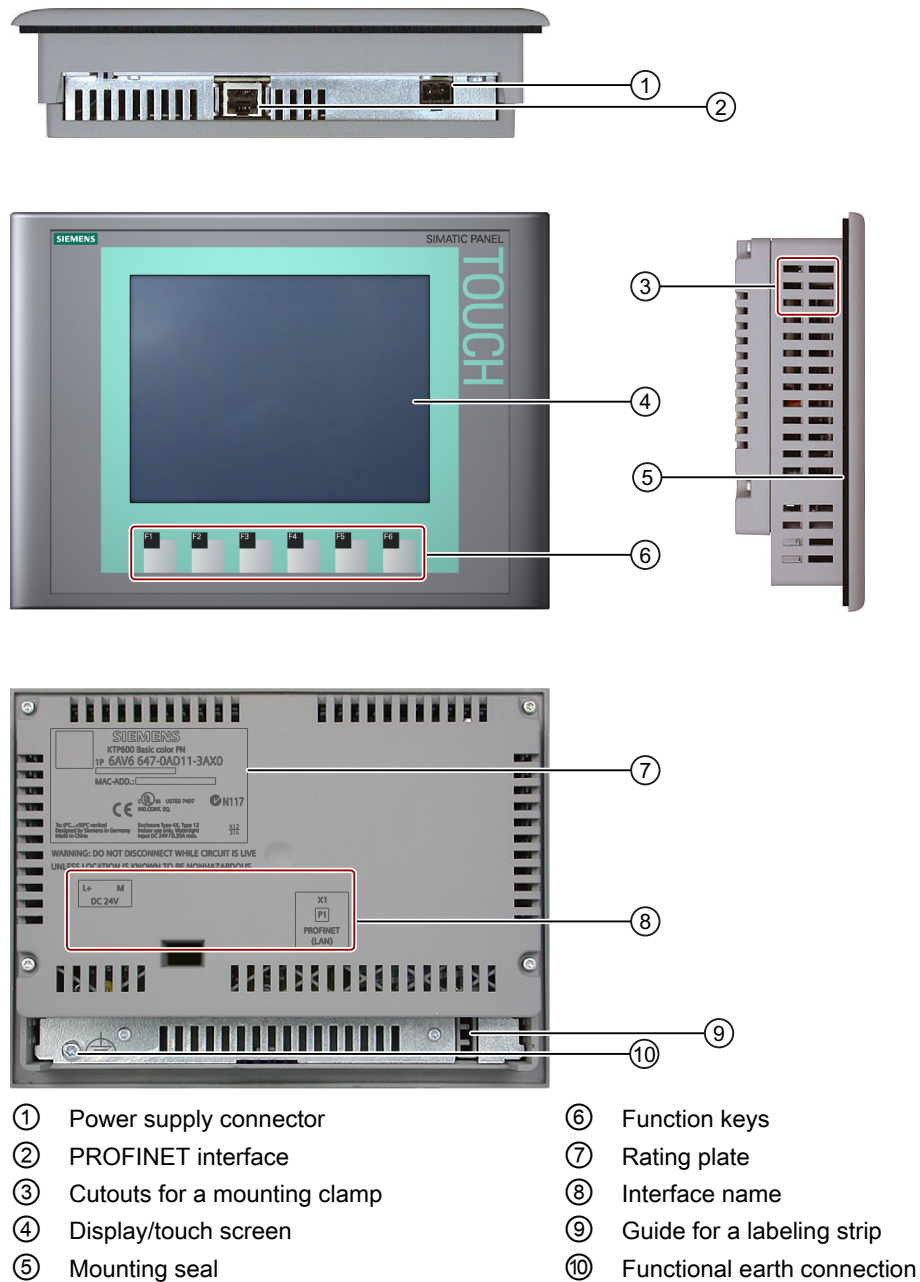

# 1.7 Design of the KTP600 Basic color DP

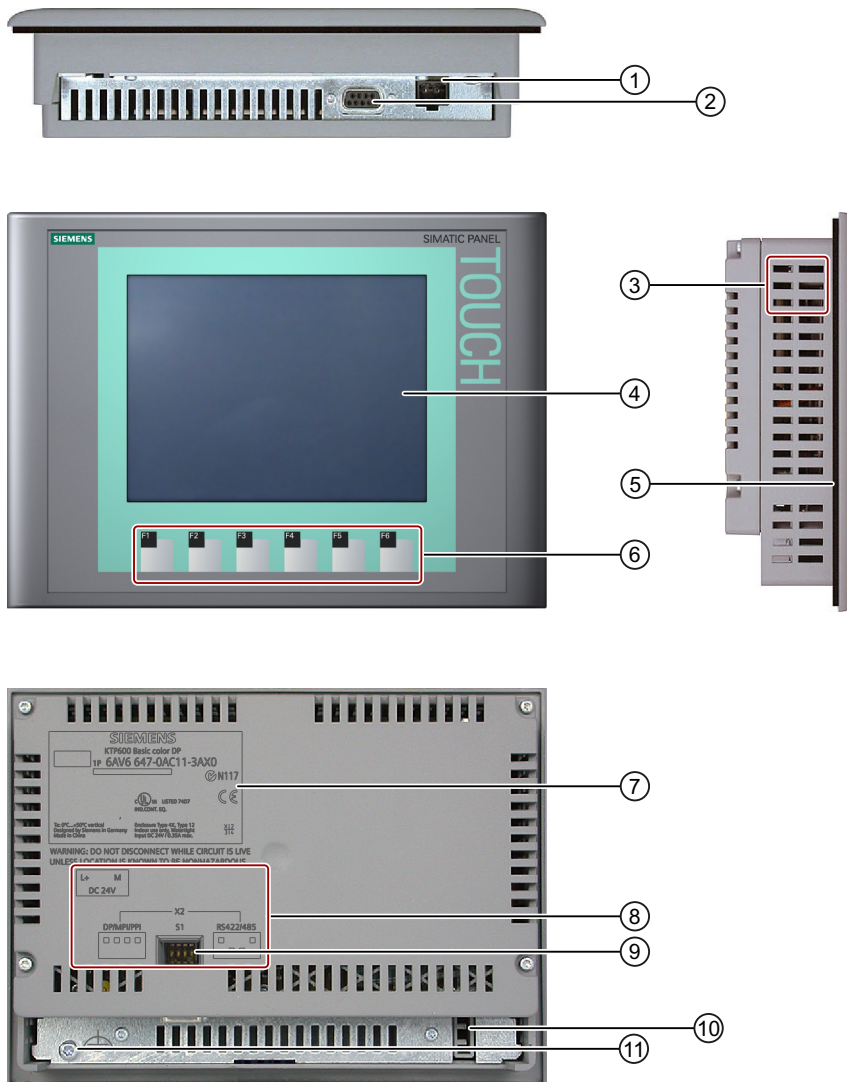

- ① Power supply connector
- ② RS-422/RS-485 interface
- ③ Cutouts for a mounting clamp
- ④ Display/touch screen
- ⑤ Mounting seal
- ⑥ Function keys
- ⑦ Rating plate
- ⑧ Interface name
- ⑨ DIP switch
- ⑩ Guide for a labeling strip
- ⑪ Functional earth connection

## 1.8 Design of the KTP1000 Basic color PN

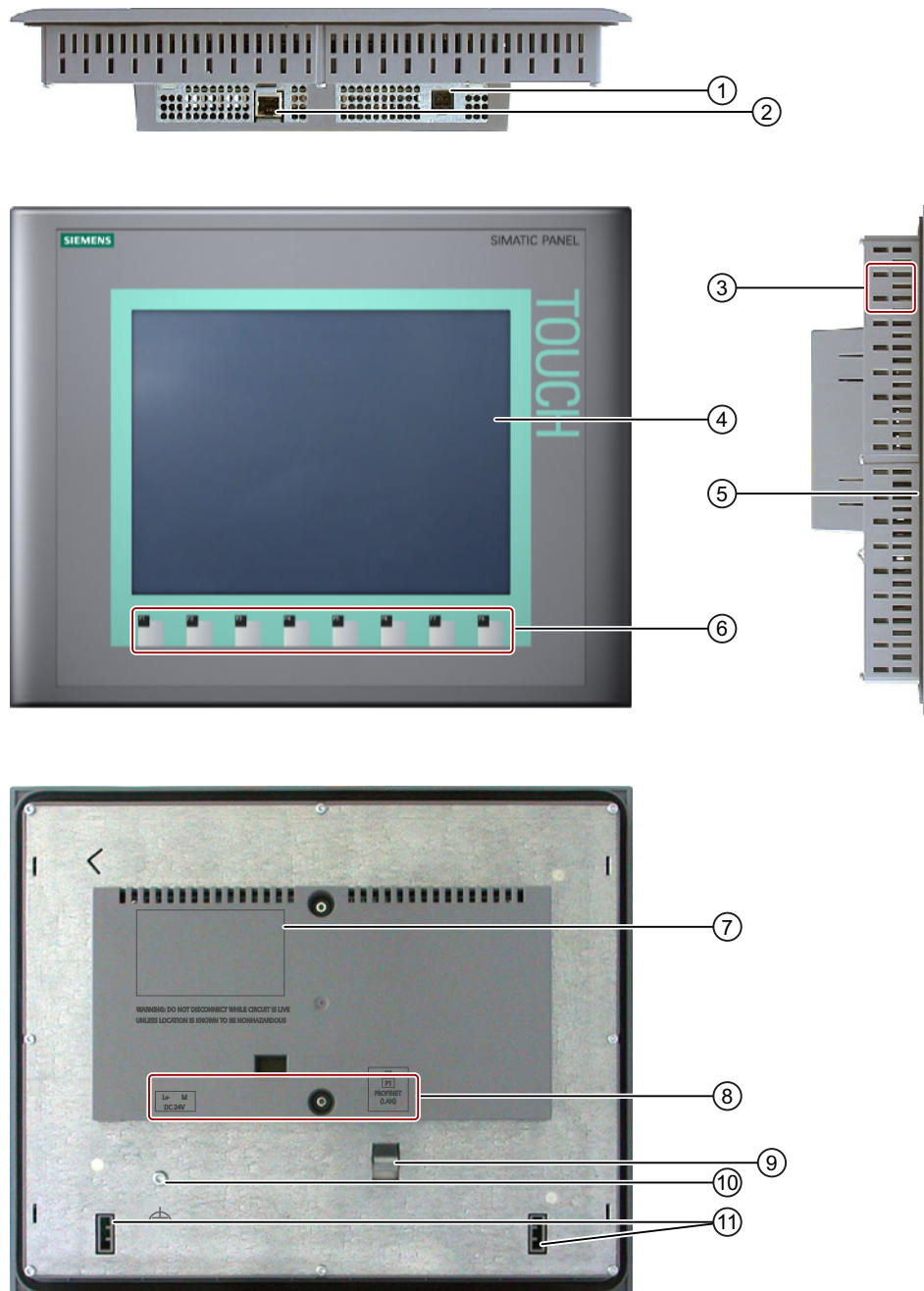

- |                                |                               |
|--------------------------------|-------------------------------|
| ① Power supply connector       | ⑦ Rating plate                |
| ② PROFINET interface           | ⑧ Interface name              |
| ③ Cutouts for a mounting clamp | ⑨ Fixing element              |
| ④ Display/touch screen         | ⑩ Functional earth connection |
| ⑤ Mounting seal                | ⑪ Guide for labeling strips   |
| ⑥ Function keys                |                               |

### 1.9 Design of the KTP1000 Basic color DP

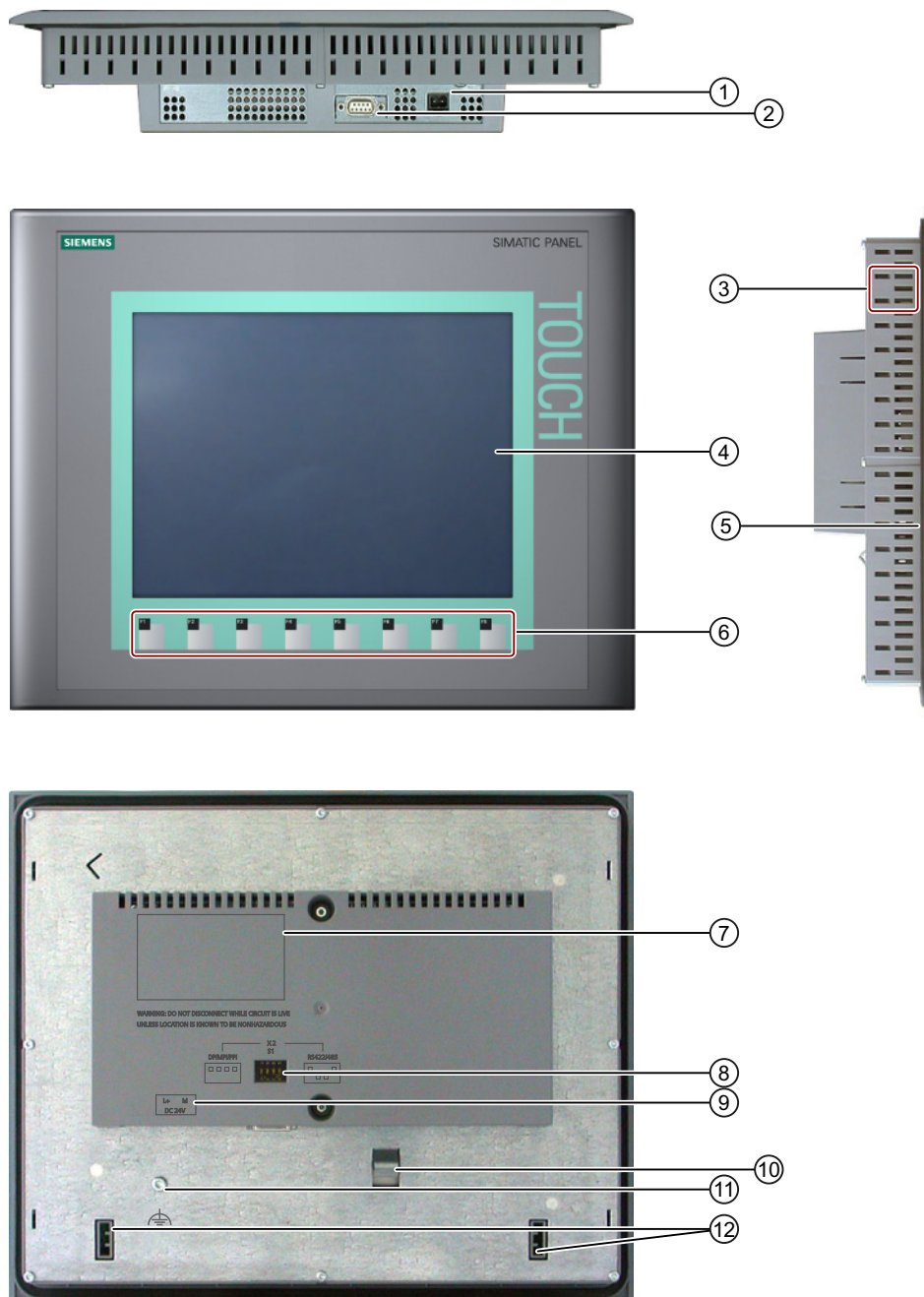

- |                                |                               |
|--------------------------------|-------------------------------|
| ① Power supply connector       | ⑦ Rating plate                |
| ② RS-422/RS-485 interface      | ⑧ DIP switch                  |
| ③ Cutouts for a mounting clamp | ⑨ Interface name              |
| ④ Display/touch screen         | ⑩ Fixing element              |
| ⑤ Mounting seal                | ⑪ Functional earth connection |
| ⑥ Function keys                | ⑫ Guides for labeling strips  |

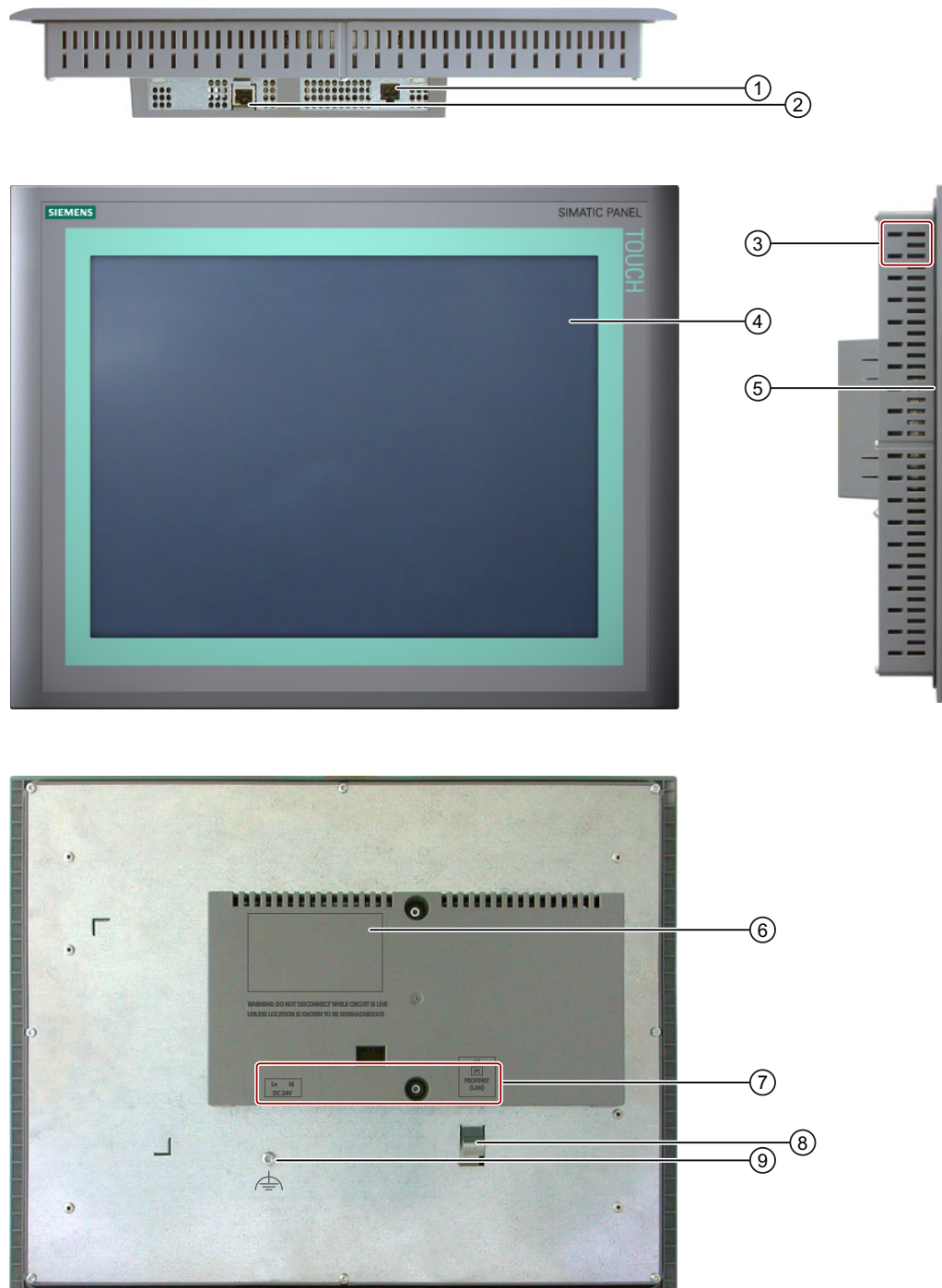

## 1.10 Design of the TP1500 Basic color PN



- |                                |                               |
|--------------------------------|-------------------------------|
| ① Power supply connector       | ⑥ Rating plate                |
| ② PROFINET interface           | ⑦ Interface name              |
| ③ Cutouts for a mounting clamp | ⑧ Fixing element              |
| ④ Display/touch screen         | ⑨ Functional earth connection |
| ⑤ Mounting seal                |                               |

## 1.11 Product package

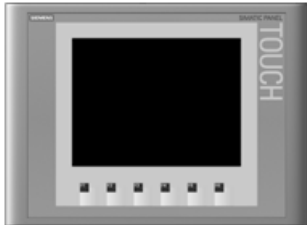
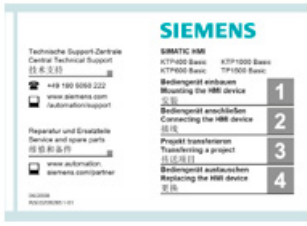
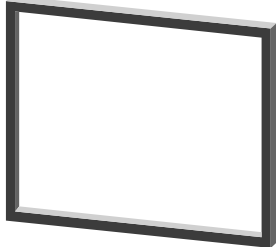
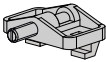
The following components are included in the product package of the HMI device.

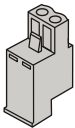
Name	Figure	Quantity	
HMI device		1	
Quick Installation Guide		1	
Mounting seal		1 Included with KTP 600 Basic and already installed with all other HMI devices.	
Mounting clamps with grub screw		4	KP300 Basic
		7	KP400 Basic
		5	KTP400 Basic color PN
		5	KTP400 Basic mono PN
		6	KTP600 Basic
		12	KTP1000 Basic
14	TP1500 Basic		
Power supply terminal		1	

## 1.12 Accessories

Accessories are not included in the product package of the HMI device, but can be ordered on the Internet under Industry Mall (<http://mall.automation.siemens.com>).

This section contains the number of accessories available at the time of publication of the operating instructions.

### Converters, adapters and connectors

Name	Purpose	Order no.
RS 422 to RS 232 converter	Connection of third-party controllers to Basic Panels DP	6AV6671-8XE00-0AX0
PC/PPI cable	Converts RS 422/RS 485 signals to RS 232 signals. Is required for updating the operating system with reset to factory settings <sup>1</sup> . Can also be used for the transfer.	6ES7 901-3CB30-0XA0
90 degree elbow adapter	For RS422/RS485 interface, cable outlet to rear	6AV6671-8XD00-0AX0
USB/PPI cable	Converts RS 422/RS 485 signals to USB signals. Is required for updating the operating system with reset to factory settings. Can also be used for the transfer.	6ES7 901-3DB30-0XA0
PROFIBUS connector	Recommended PROFIBUS connector with straight cable outlet	6GK1500-0FC10
PROFINET RJ45 connector "IE FC RJ45 Plug 2x2"	Required for connection of Basic Panels PN to PROFINET	6GK1901-1BB10-2AA0

<sup>1</sup> If the connection is lost during the operating system update, set a lower bit rate. If you use a higher bit rate, you must use the PC/PPI cable release 3 or higher. The release code is printed on the cable ("E version 3," for example, corresponds to release 3).

### Clamping frame

Name	Purpose	Order no.
Clamping frame for 10"/12" Touch	For reinforcement of the mounting cutout for KTP1000 Basic when material is not thick enough	6AV6 671-8XS00-0AX0

**Protective foil**

Name	Purpose	Order no.
Protective foil 4"	Protective foil set for KTP400 Basic mono PN	6AV6 671-2EC00-0AX0
Protective foil 4" widescreen	Protective foil set for KTP400 Basic color PN	6AV2124-6DJ00-0AX0
Protective foil 6"	Protective foil set for KTP600 Basic	6AV6 671-2XC00-0AX0
Protective foil 10"	Protective foil set for KTP1000 Basic	6AV6 671-3DC00-0AX5
Protective foil 15"	Protective foil set for TP1500 Basic color PN	6AV6 574-1AD00-4EX0

**Service packages**

Purpose	Order no.
Set with 20 plastic clamps for KP300 Basic Mono PN, KP400 Basic color PN and KTP400 Basic color PN	6AV6671-8KX00-0AX2
Set with 20 aluminum mounting clamps for Basic Panels from 4"	6AV6671-8XK00-0AX0
Set of 10 power supply terminals	6AV6671-8XA00-0AX0

**1.13 Commissioning the HMI device**

This section contains an overview of the tasks required for commissioning the HMI device.

	Description	Section
1.	Familiarize yourself with the safety instructions.	Safety instructions (Page 25)
2.	Prepare the HMI device for mounting.	Preparations (Page 29)
3.	Install the HMI device.	Mounting the HMI device (Page 34)
4.	Connect the equipotential bonding.	Connecting the equipotential bonding circuit (Page 38)
5.	Connect the power supply.	Connecting the power supply (Page 39)
6.	Connect a configuration PC.	Connecting the configuration PC (Page 42)
7.	Enable sharing for data channel on the HMI device.	Enabling a data channel (Page 76)
8.	Transfer a project.	Starting manual transfer (Page 91)
9.	After transferring the project, disconnect the HMI device from the configuration PC and connect the HMI device to the PLC.	Connecting the PLC (Page 45)



# Safety instructions

## 2.1 General safety instructions

### Working on the control cabinet

 <b>WARNING</b>
<b>Open equipment</b> The HMI device is open equipment. That means that the HMI device may only be installed in cubicles or cabinets that provide front panel access for operating the device. The cubicle or cabinet in which the HMI device is installed may only be accessed with a key or tool and only by trained, authorized personnel. <b>Dangerous voltage</b> Opening the cabinet will expose high voltage parts. Contact with these parts could be fatal. Always disconnect the cabinet from the mains before opening it.

### High frequency radiation

<b>NOTICE</b>
<b>Unwanted operating states</b> High-frequency radiation, for example, from cellular phones, can trigger unwanted operating states.

### Installation as intended

 <b>WARNING</b>
<b>Installation only in machinery that conforms to the machinery directive</b> It is not allowed to commission the HMI device unless it has been verified that the machine in which the HMI device is to be installed complies with Directive 2006/42/EC.

## 2.2 Security information

Siemens offers IT security mechanisms for its portfolio of automation and drive products in order to support safe operation of the plant/machine. We recommend that you stay informed about the IT security developments for your products. For information on this topic, refer to: Industry Online Support ([http://www.siemens.de/automation/csi\\_en\\_VW](http://www.siemens.de/automation/csi_en_VW)): You can register for a product-specific newsletter here.

For the safe operation of a plant/machine, however, it is also necessary to integrate the automation components into an overall IT security concept for the entire plant/machine, which corresponds to the state-of-the-art IT technology. You can find information on this under: Industrial Security (<http://www.siemens.com/industrialsecurity>).

Products used from other manufacturers should also be taken into account here.

## 2.3 Notes about usage

<b>CAUTION</b>
<b>HMI device approved for indoor use only</b>
The HMI device may be damaged if operated outdoors.
Operate the HMI device indoors only.

### Industrial applications

The HMI device is designed for industrial applications. It conforms to the following standards:

- Requirements of the emission standard for industrial environments, EN 61000-6-4: 2007
- ESD immunity requirements to DIN EN 61000-6-2:2005

#### Use in residential areas

---

**Note**

The HMI device is not intended for use in residential areas. Operation of an HMI device in residential areas can have a negative influence on radio/TV reception.

---

If the HMI device is used in a residential area, you must take measures to achieve Limit Class B conforming to EN 55011 for RF interference.

A suitable measure for achieving the RF interference level to Limit Class B is, for example, the use of filters in power supply lines.

Individual acceptance is required.

## Notes on communication

<b>NOTICE</b>
<b>Communication errors caused by address conflict</b>
Communication errors can occur if several devices in a network share the same bus address or IP address.
Make sure that your HMI device is assigned a unique address in the network.

---

### **Note**

#### **Updating tag values following a communication error**

If communication between an HMI device and PLC is interrupted, all tag values displayed on the HMI device will be replaced by a hash mark ("#").

When the communication between the HMI device and PLC is restored, all tag values will be updated immediately. The cycle time for updating the tag values begins again at "0."

#### **Ethernet communication with Basic Panels PN**

Basic Panels PN support the following types of communication:

- PROFINET basic function for commissioning and diagnostics
  - Standard Ethernet communication
-



## Mounting and connecting

### 3.1 Preparations

#### 3.1.1 Checking the package contents

Check the package content for visible signs of transport damage and for completeness.

<b>NOTICE</b>
<b>Damaged parts</b>
Do not install parts damaged during shipment. In the case of damaged parts, contact your Siemens representative.

The package content is described in section Product package (Page 22).

Keep the supplied documentation in a safe place. The documentation belongs to the HMI device and is required for subsequent commissioning.

#### 3.1.2 Checking the operating conditions

Note the following aspects before installing the HMI device:

1. Familiarize yourself with the standards, approvals, EMC parameters and technical specifications for operation of the HMI device. This information is available in the following chapters:
  - Certificates and approvals (Page 117)
  - Electromagnetic compatibility (Page 118)
  - Information on insulation tests, protection class and degree of protection (Page 140)
  - Power supply (Page 131)
2. Check the mechanical and climatic ambient conditions for operation of the HMI device; see Conditions of use (Page 138).

#### 3.1.3 Selecting a mounting position

Select one of the approved mounting positions for your HMI device. The approved mounting positions are described in the following sections.

Horizontal mounting position

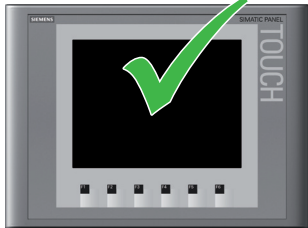
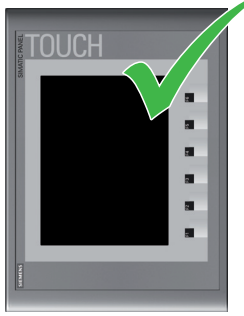
	<p>All Basic HMI devices are suitable for horizontal mounting positions.</p> <p>The maximum ambient temperature at the device with vertical mounting in horizontal positions is 50 °C</p>
	<p>The following Basic HMI devices are also suitable for vertical mounting positions:</p> <ul style="list-style-type: none"> <li>• KTP400 Basic</li> <li>• KTP600 Basic</li> </ul> <p>The maximum ambient temperature at the device with vertical mounting in vertical positions is 40 °C</p>

Angled mounting position

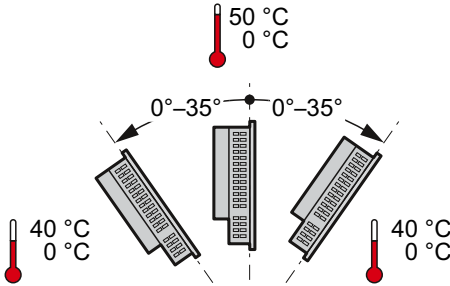
	<p>The Basic HMI devices are self-ventilating. Vertical and angled mounting is permitted in:</p> <ul style="list-style-type: none"> <li>• Mounting cabinets</li> <li>• Control cabinets</li> <li>• Switchboards</li> <li>• Consoles</li> </ul>
---	--

**⚠ CAUTION**

**Exceeding the ambient temperature**

Forced ventilation is required if the maximum permitted ambient temperature for operating the HMI device is exceeded. The HMI device can otherwise be damaged and its approvals and warranty will be void.

See also

Conditions of use (Page 138)

### 3.1.4 Checking clearances

The following clearances are required around the HMI device to ensure sufficient self-ventilation:

Required clearance around the HMI devices.  
All dimensions in mm

	x	y	z
KP300 Basic	15	40	10
KP400 Basic	15	40	10
KTP400 Basic	15	40	10
KTP600 Basic	15	40	10
KTP1000 Basic	15	50	10
TP1500 Basic	15	50	10

### 3.1.5 Making the mounting cut-out

#### NOTICE

##### Stability of the mounting cutout

The material in the area of the mounting cutout must provide sufficient strength to guarantee the enduring and safe mounting of the HMI device.

The force of the mounting clamps or operation of the device may not lead to deformation of the material in order to achieve the degrees of protection described below.

#### Degrees of protection

The degrees of protection of the HMI device can only be guaranteed if the following requirements are met:

- Material thickness at the mounting cutout 2 mm to 6 mm for IP65 degree of protection or Front face only Type 4X/Type 12 (indoor use only) degree of protection. The thickness is 2 mm to 4 mm for the KP300 Basic mono PN.
- Permitted deviation from plane at the mounting cutout:  $\leq 0.5$  mm  
This condition must be fulfilled for the mounted HMI device.
- Permissible surface roughness in the area of the seal:  $\leq 120$   $\mu\text{m}$  ( $R_z$  120)

A clamping frame is additionally available for the HMI device KTP1000 Basic with a material thickness  $< 2$  mm at the mounting cutout. The frame enables you to achieve degree of protection IP65 or Front face only Type 4X/Type 12.

**Mounting compatibility**

The mounting cutouts of the Basic panels are compatible with the mounting cutouts of the following SIMATIC HMI devices:

Mounting cutout for the Basic Panel	Compatible to the mounting cutouts of the HMI device
KP400 Basic	OP77A, OP77B
KTP400 Basic	TP 177B 4"
KTP600 Basic	TP 177 A, TP 177B 6", TP 177micro
KTP1000 Basic	MP 277 10" Touch, MP 377 12" Touch
TP1500 Basic	MP 377 15" Touch, Thin Client 15" Touch

**Dimensions of the mounting cutout**

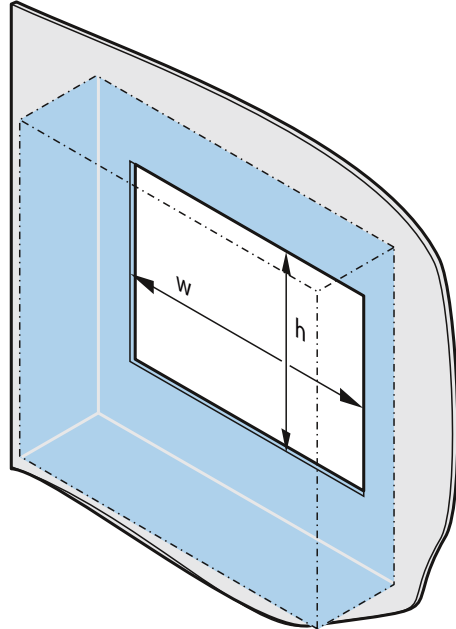

Dimensions of the mounting cutout for the basic HMI devices in horizontal mounting position:

	$w_0^{+1}$	$h_0^{+1}$
KP300 Basic	149	82
KP400 Basic	135	171
KTP400 Basic	123	99
KTP600 Basic	197	141
KTP1000 Basic	310	248
TP1500 Basic	367	289

Dimensions of the mounting cutout for the basic HMI devices in vertical mounting position:

	$w_0^{+1}$	$h_0^{+1}$
KTP400 Basic	99	123
KTP600 Basic	141	197

All dimensions in mm

**See also**

Accessories (Page 23)



### 3.1.6 Labeling the function keys

The KP300 Basic has no function keys that can be labeled.

#### Note



Do not write on the keyboard to label the function keys.

Any printable and writable foil can be used as labeling strip. The permitted thickness of the labeling strip is 0.15 mm. Paper labeling strips are inappropriate.

	<ol style="list-style-type: none"> <li>1. Edit the template on the PC. The template is available in the "CD_3\Documents\ &lt;language&gt;\Slides" directory on the WinCC/WinCC flexible DVD or on the Internet at:  Downloads for Basic Panels (<a href="http://support.automation.siemens.com/WW/view/en/28426379/133100">http://support.automation.siemens.com/WW/view/en/28426379/133100</a>)</li> <li>2. Print the edited template on foil.</li> <li>3. Apply a fixing spray film to the labeling strips.</li> <li>4. Wait approx. 5 minutes until the fixing spray is dry and smear-proof.</li> <li>5. Cut out the labeling strip.</li> <li>6. Cut off the corners of the labeling strips at an angle of 45° to make it easier to insert them.</li> <li>7. Slide the labeling strips into the slot up to the end of the guide.</li> </ol> <p>The labeling strips will protrude approximately 3 cm out of the guide. The template dimensions for the labeling strips are designed so that the labeling is correctly placed for the function keys. It is not necessary to secure the labeling strip.</p>
--	---

### 3.2 Mounting the HMI device

#### Required tools and accessories

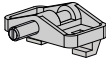
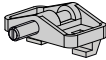
	Slotted screwdriver, size 2		
	Mounting clamp type	For HMI device	Required quantity
	Aluminum mounting clamps	KTP400 Basic mono	5
		KTP600 Basic	6
		KTP1000 Basic	12
	Plastic mounting clamps	TP1500 Basic:	14
		KP300 Basic	4
		KP400 Basic	7
KTP400 Basic color	5		

#### Inserting the HMI device

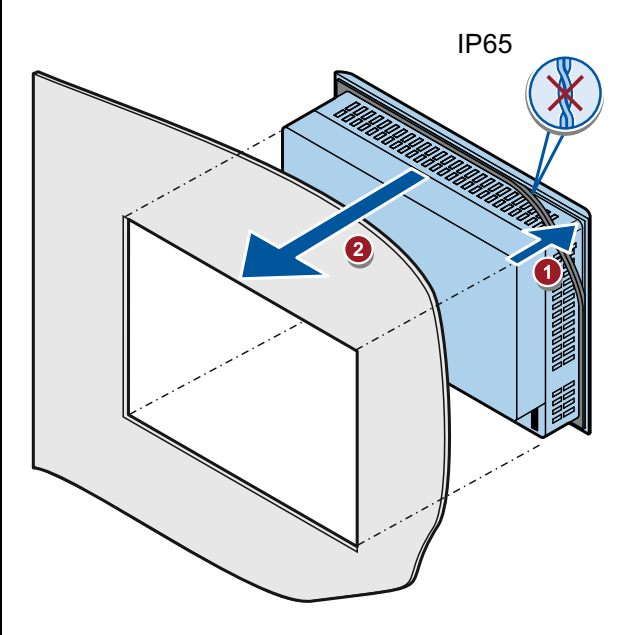

1. If necessary, insert the mounting seal in the groove on the back of the HMI device front panel.  
Make sure that the mounting seal is not twisted. A correctly inserted mounting seal is required to ensure IP65 degree of protection.
2. Insert the HMI device into the mounting cutout from the front.  
Ensure that the protruding labeling strips are not caught between the mounting cutout and HMI device.

### Securing the HMI device with aluminum mounting clamps

**≤ 0.2 Nm**

1. Insert the first clamp at the first position of the cutouts on the back of the HMI device.

Set the clamp positions for your HMI device to match those of the figures in the following table row.

2. Secure the clamps using a size 2 screwdriver. The maximum permitted torque is 0.2 N/m.
3. Repeat steps 1 to 2 for all mounting clamps required to secure your HMI device.

KTP400  
Basic mono

KTP600 Basic

TP1500 Basic

KTP1000 Basic

**Securing the HMI device with plastic mounting clamps**



1. If mounting clamps and grub screws are available separately in the accessories bag, insert a grub screw into the mounting clamp bore hole and turn it several times.
2. Place the first mounting clamp into the corresponding cutout.
3. Secure the clamps using a size 2 screwdriver. The maximum permitted torque is 0.2 N/m.
4. Repeat steps 1 to 3 for all mounting clamps required to secure your HMI device.



**3.3 Connecting the HMI device**

**3.3.1 Connection sequence**

**Required tools and accessories**

Before beginning the connection of the HMI device, have the following tools and accessories at hand:

	Slotted screwdriver, size 2
	Phillips screwdriver, size 3

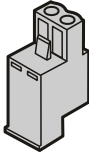
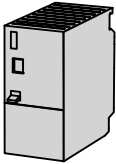
	Torx screwdriver, size TX20
	Crimp pliers
	Power supply terminal
	24 VDC with sufficient amperage. See Specifications (Page 131)

## Procedure

Keep to the following sequence of tasks when connecting the HMI device:

1. Connecting the equipotential bonding circuit (Page 38)
2. Connecting the power supply (Page 39)
3. Connecting the configuration PC (Page 42)
4. Connecting the PLC (Page 45)

### NOTICE

#### Strain relief

Contacts can be broken or wires can be torn off if cables are not provided adequate strain relief.

Provide adequate strain relief for all cables.

## See also

Securing the cables (Page 50)

### 3.3.2 Connecting the equipotential bonding circuit

#### Differences in electrical potential

Differences in electrical potential can develop between spatially separated plant components. Such electrical potential differences can lead to high equalizing currents over the data cables and therefore to the destruction of their interfaces. Equalizing currents can develop if the cable shielding is terminated at both ends and grounded to different plant parts.

Differences in potential may develop when a system is connected to different mains supplies.

#### General requirements for equipotential bonding

Differences in potential must be reduced by means of equipotential bonding in order to ensure trouble-free operation of the relevant components of the electronic system. The following must therefore be observed when installing the equipotential bonding circuit:

- The effectiveness of equipotential bonding increases as the impedance of the equipotential bonding conductor decreases or as its cross-section increases.
- If two plant parts are interconnected by means of shielded data cables and their shielding is bonded at both ends to the grounding/protective conductor, the impedance of the additionally installed equipotential bonding cable must not exceed 10% of the shielding impedance.
- The cross-section of an equipotential bonding conductor must be capable of handling the maximum equalizing current. The best practical results for equipotential bonding between two cabinets have been achieved with a minimum conductor cross-section of 16 mm<sup>2</sup>.
- Use equipotential bonding conductors made of copper or galvanized steel. Establish a large surface contact between the equipotential bonding conductors and the grounding/protective conductor and protect these from corrosion.
- Clamp the shielding of the data cable on the HMI device flush and near the equipotential rail using suitable cable clamps.
- Route the equipotential bonding conductor and data cables in parallel and with minimum clearance between these.

<b>NOTICE</b>
<b>Equipotential bonding cable</b> Cable shielding is not suitable for equipotential bonding. Always use the prescribed equipotential bonding conductors. The cross-section of the equipotential bonding conductor must not be less than 16 mm <sup>2</sup> . Always use cables with an adequate cross-section when installing MPI and PROFIBUS DP networks. The interface modules may otherwise be damaged or destroyed.

## Procedure

<p>4 mm<sup>2</sup></p> <p>≥ 16 mm<sup>2</sup></p> <p>≥ 16 mm<sup>2</sup></p> <p>— PROFIBUS — PROFINET</p>	<ol style="list-style-type: none"> <li>1. Interconnect functional ground of the HMI device with an grounding cable, cross-section 4 mm<sup>2</sup>.</li> <li>2. Connect the grounding cable of the HMI device to the equipotential bonding rail.</li> </ol>
--	---

### 3.3.3 Connecting the power supply

#### Stripping the cable

<p>6 mm</p>	<p>Use power supply cables with a maximum cross-section of 1.5 mm<sup>2</sup>.</p> <ol style="list-style-type: none"> <li>1. Strip the ends of two power supply cables to a length of 6 mm.</li> <li>2. Attach cable sleeves to the bare cable ends.</li> <li>3. Fix the cable sleeve onto the cable ends using the crimp pliers.</li> </ol>
-------------	--

Procedure

**CAUTION**  
**24 VDC only**  
An incorrectly dimensioned power supply can lead to destruction of the HMI device.  
Use a 24 VDC power supply with adequate amperage; see Specifications (Page 131).

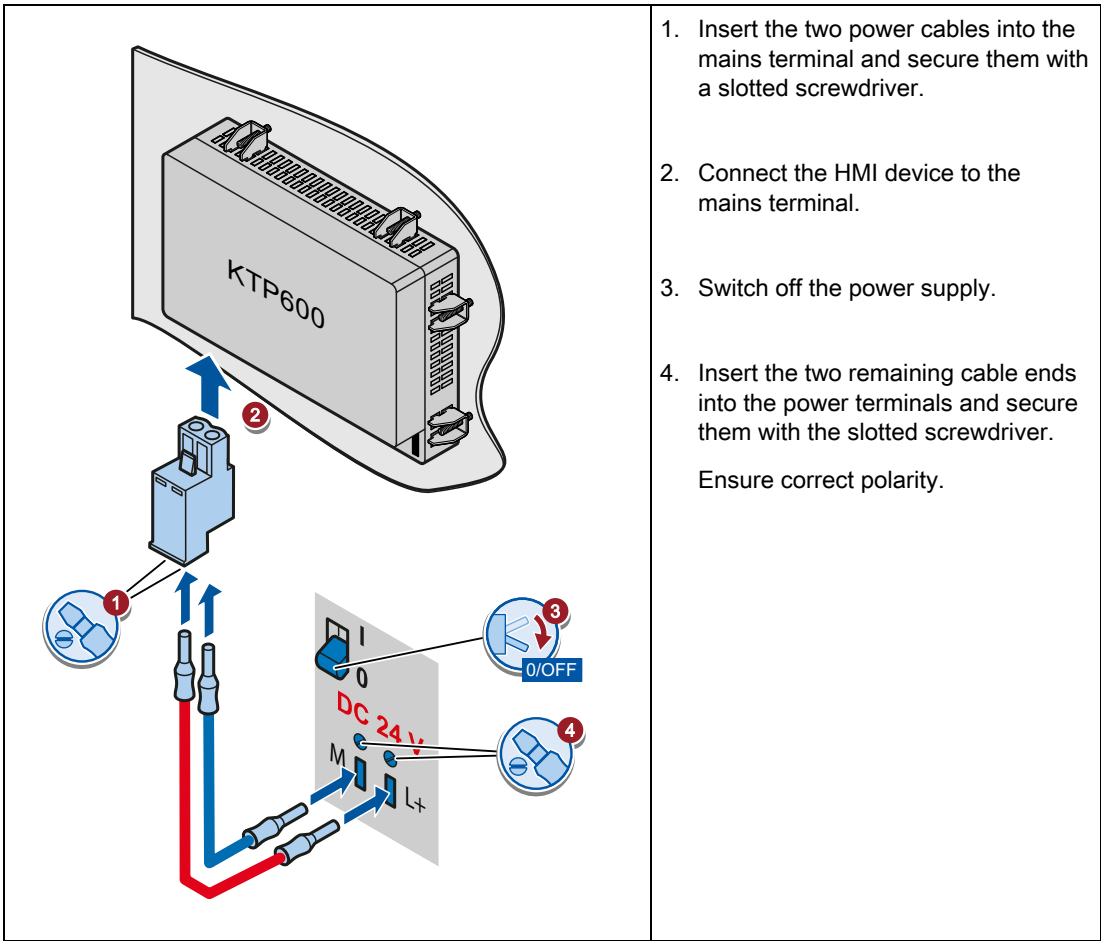



### 3.3.4 Connecting a programming device

A programming device provides the following options:

- Transferring projects.
- Transferring device images.

#### Connecting a programming device to a Basic Panel DP

##### Note

A programming device cannot be used to reset the HMI device to factory settings.

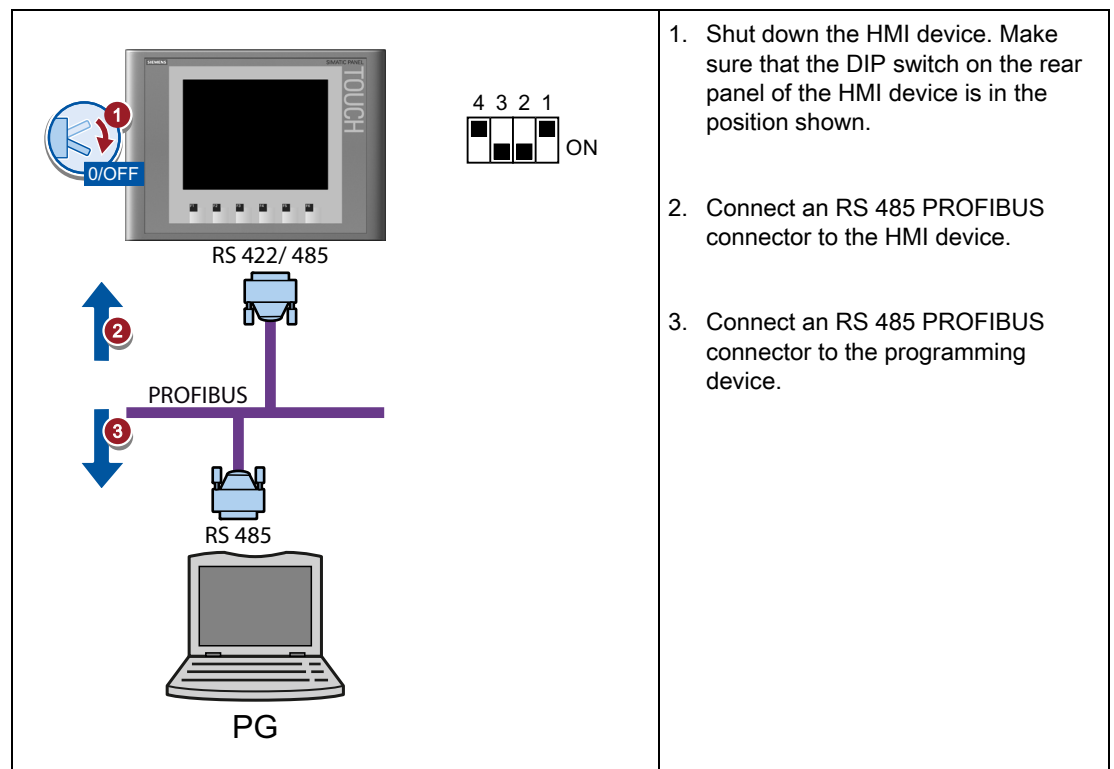

### 3.3.5 Connecting the configuration PC

A configuring PC provides the following options:

- Transferring projects.
- Transferring device images.
- Resetting HMI device to factory settings.

#### Connecting a configuring PC to a Basic Panel DP

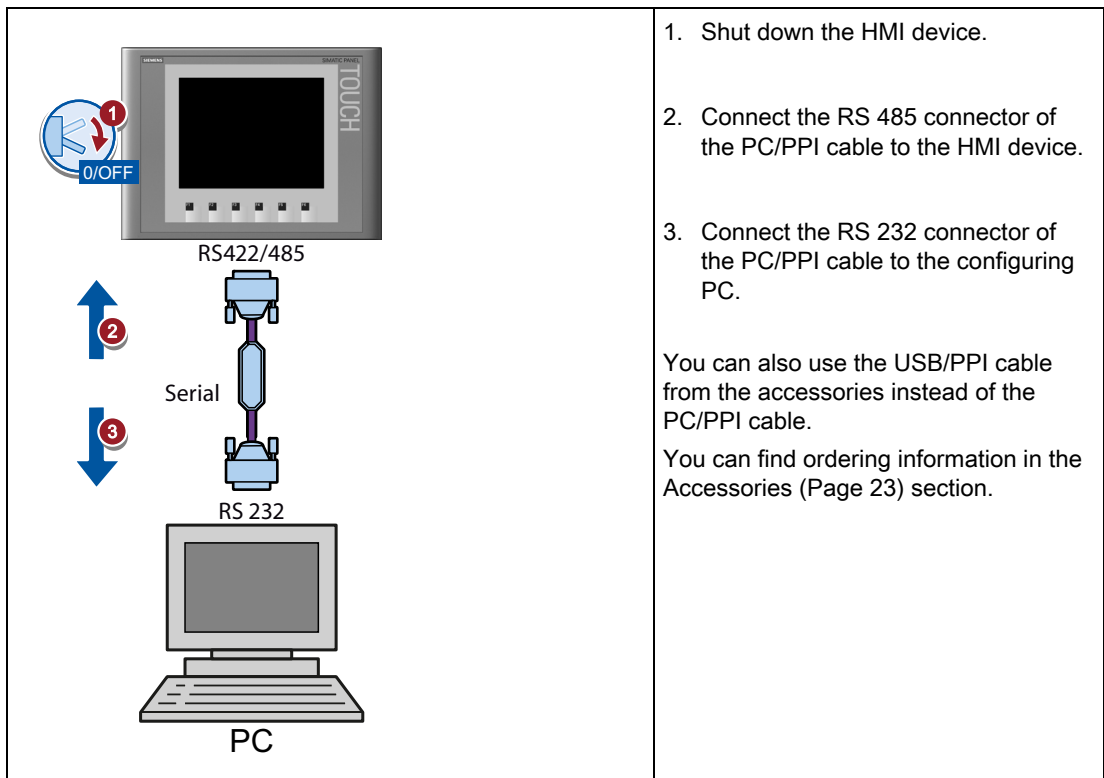

### Configuring the PC/PPI cable

Configure the transmission speed using the DIP switches of the PC/PPI cable if using the PC/PPI cable to interconnect the HMI device with the configuring PC.

**Note**

Set a lower bit rate if the connection is lost during the operating system update. If you use a higher bit rate, you must use the PC/PPI cable release 3 or higher. The version code is printed on the cable ("E stand 3," for example, corresponds to release 3).



Set the DIP switches 1 to 3 to the same value as in WinCC flexible or WinCC. DIP switches 4 to 8 must be set to "0". In the figure, the bit rate is set to 115.2 kbps.

You can set the following bit rates:

Bit rate in kbps	DIP switch 1	DIP switch 2	DIP switch 3
115.2	1	1	0
57.6	1	1	1
38.4	0	0	0
19.2	0	0	1
9.6	0	1	0
4.8	0	1	1
2.4	1	0	0
1.2	1	0	1

### Connecting a configuring PC to a Basic Panel PN

**CAUTION**

**Data network security for communication via Ethernet**

With Ethernet-based communication via PROFINET, the end user is himself responsible for the security of his data network; the proper functioning of the data network cannot be guaranteed in all circumstances, for example in the case of target attacks leading to an overloading of the device.

**NOTICE**

**RJ45 plug connector with 180° output required**

The connection of the Basic Panels PN to the HMI device requires the RJ45 plug connector "IE FC RJ45 Plug 2 x 2". You can find ordering information in the Accessories (Page 23) section.

Use a standard CAT-5 Ethernet cable to connect the configuring PC.

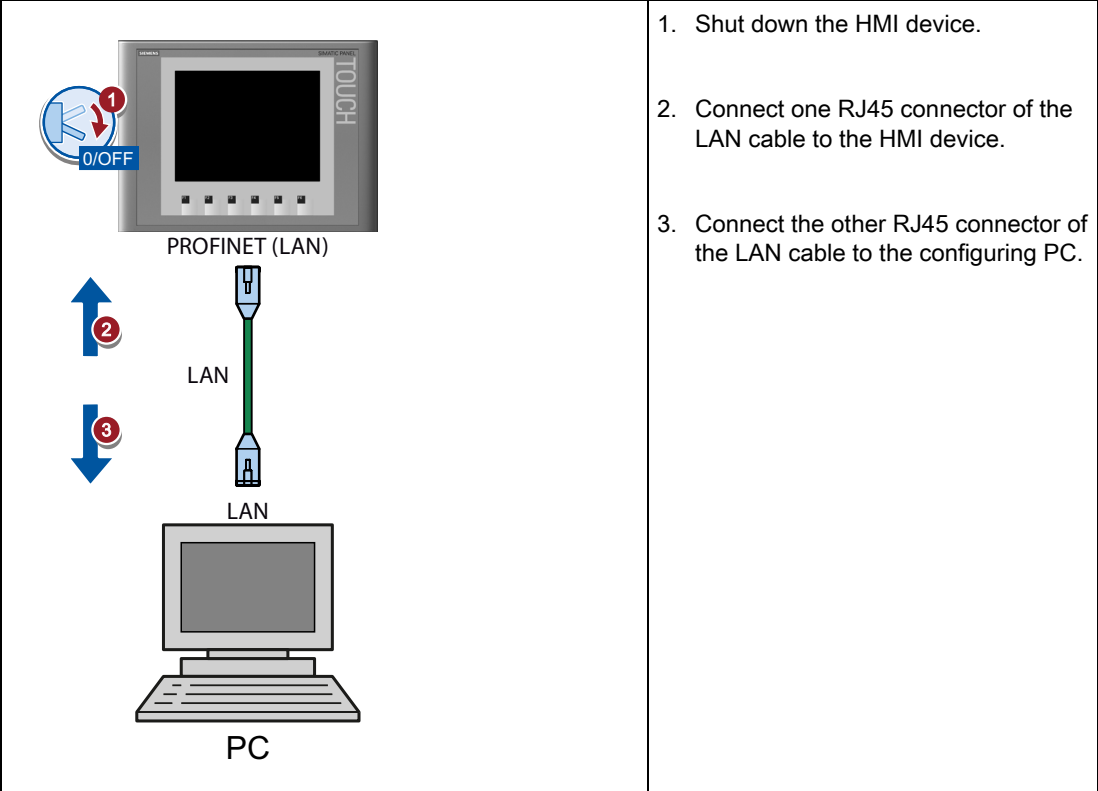

**See also**

Data transmission options (Page 91)

### 3.3.6 Connecting the PLC

If the HMI device contains an operating system and an executable project, connect the HMI device to the PLC.

#### Note

Note the following when connecting the PLC to a panel:

- Lay the data lines parallel to the equipotential bonding conductors
- Connect the shields of the data lines to the ground

#### Connecting a PLC to a Basic Panel DP

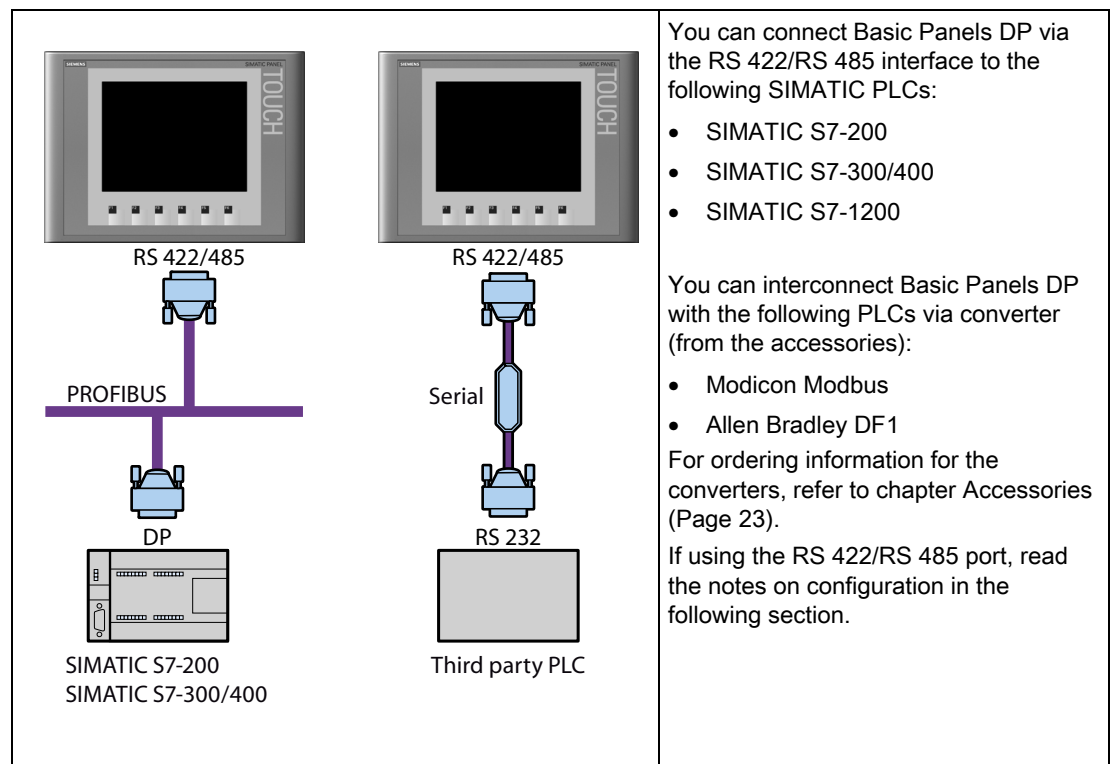

**Configuring an RS422/RS485 port**





A DIP switch for the configuration of the RS422/RS485 interface is located on the back of the HMI device.

The DIP switch is set at the factory to enable communication with the SIMATIC PLC via RS 485.

**Note**

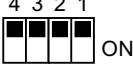
Note the diagrams of DIP switch settings on the rear panel of the HMI device.

The following table shows the DIP switch settings. The send and receive direction is toggled internally using the RTS signal.

Communication	Switch setting	Meaning
DP/MPI/PPI	<div style="text-align: center;">                     4 3 2 1   </div>	No RTS signal on connector, for data exchange between the SIMATIC PLC and the HMI device (factory state)
	<div style="text-align: center;">                     4 3 2 1   </div>	RTS signal on pin 4, same as PLC, for example, for commissioning
	<div style="text-align: center;">                     4 3 2 1   </div>	RTS signal on pin 9, same as for a programming device, for example, for commissioning
RS 422/RS 485	<div style="text-align: center;">                     4 3 2 1   </div>	RS 422/RS 485 interface is active, for example, for connecting PLCs of other manufacturers

## Connecting the PLC to a Basic Panel PN

### CAUTION

#### Data network security for communication via Ethernet

With Ethernet-based communication via PROFINET, the end user is himself responsible for the security of his data network; the proper functioning of the data network cannot be guaranteed in all circumstances, for example in the case of target attacks leading to an overloading of the device.

### NOTICE

#### RJ45 plug connector with 180° output required

The connection of the Basic Panels PN to the HMI device requires the RJ45 plug connector "IE FC RJ45 Plug 2 x 2". You can find ordering information in the Accessories (Page 23) section.

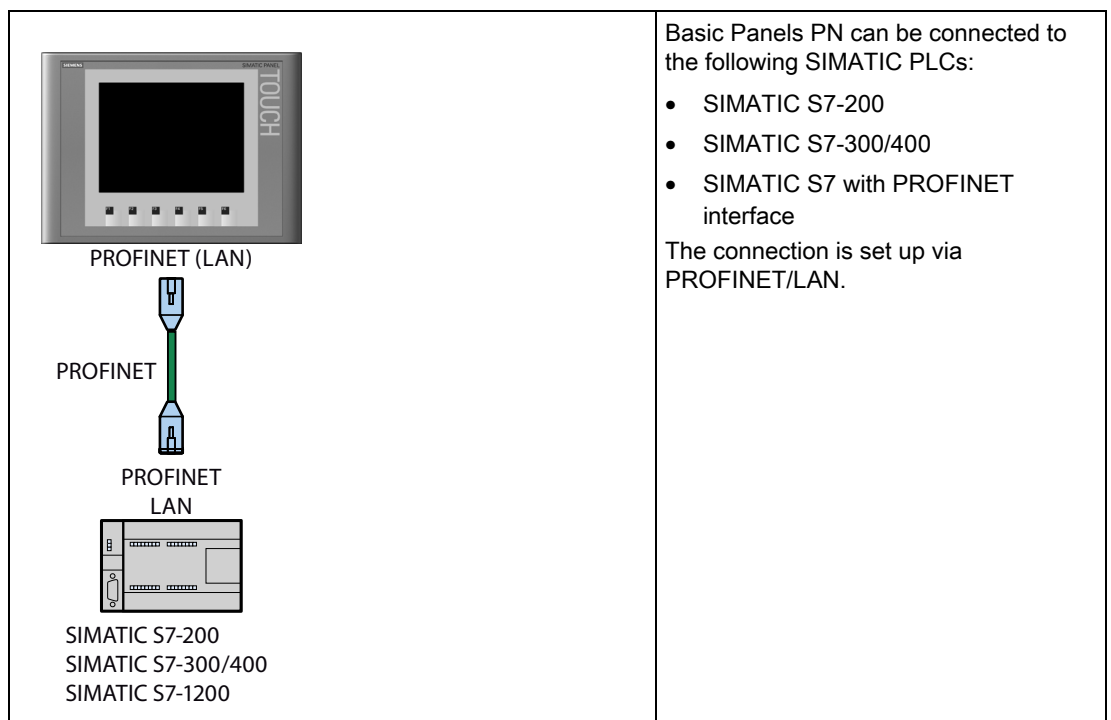

### See also

Connecting the equipotential bonding circuit (Page 38)

### 3.4 Switching on and testing the HMI device

Switching on the HMI device.

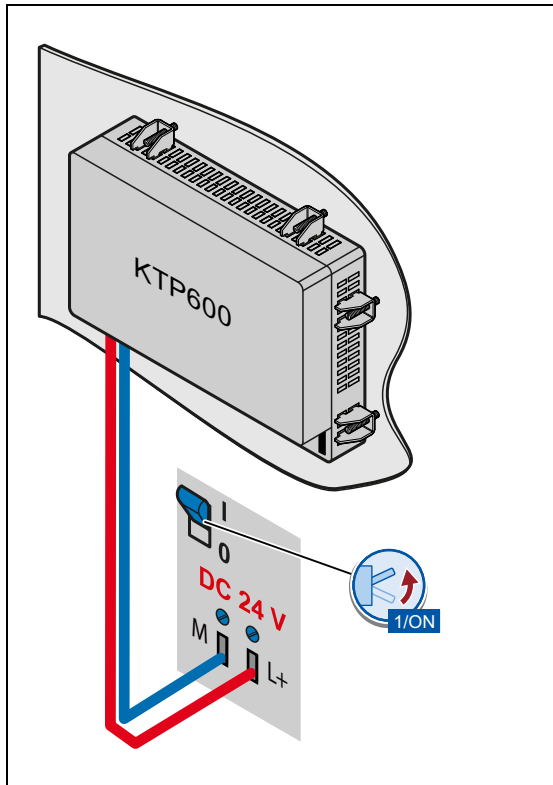
	<p>Switching on the power supply.</p> <p>The screen lights up after power is switched on. A progress bar is displayed during startup.</p> <p>If the HMI device fails to start, you have probably crossed the wires on the power supply terminal. Check the connected wires and change their connection.</p>
--	---



The Loader opens after the operating system has started.

- Touch devices: You operate the loader via the buttons on the touch screen
- Key devices: You use the cursor keys to operate the loader menu. You use the <ENTER> key to execute a menu command or switch to a submenu.

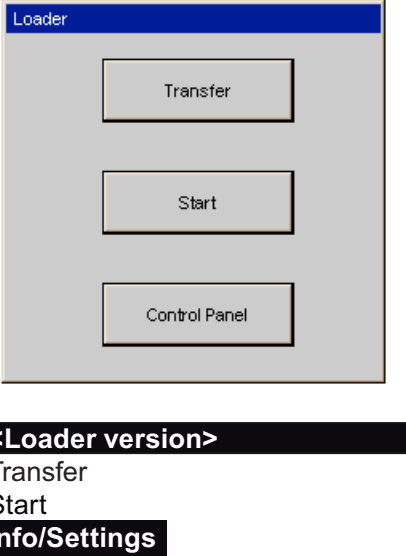
 <p>The screenshot shows a graphical user interface for a loader. At the top, there is a blue header bar with the word "Loader" in white. Below this, there are three rectangular buttons stacked vertically, labeled "Transfer", "Start", and "Control Panel". Below the buttons, there is a black bar with the text "&lt;Loader version&gt;" in white. Underneath this bar, the words "Transfer", "Start", and "Info/Settings" are listed vertically, with "Info/Settings" highlighted in a black box.</p>	<ul style="list-style-type: none"> <li>• Press the "Transfer" button or use the "Transfer" menu command to set the HMI device to "Transfer" mode. The transfer mode can only be activated when at least one data channel has been enabled for the transfer.</li> <li>• Press the "Start" button or use the "Start" menu command to start the project on the HMI device. If you do not perform an operation, the project on the HMI device will automatically start after a delay.</li> <li>• Press the "Control Panel" button or use the "Info/Settings" menu command to open the Control Panel of the HMI device. You can change various settings in the Control Panel, for example, the transfer settings.</li> </ul>
--	---

### Shutting down the HMI Device

1. Close any active projects on the HMI device.
2. Shut down the HMI device. You have the following shutdown options:
  - Switch off the power supply.
  - Remove the power supply terminal from the HMI device.

### 3.5 Securing the cables

The following HMI devices come equipped with a fixing element on the back for strain relief:

- KTP1000 Basic DP
- KTP1000 Basic PN
- TP1500 Basic

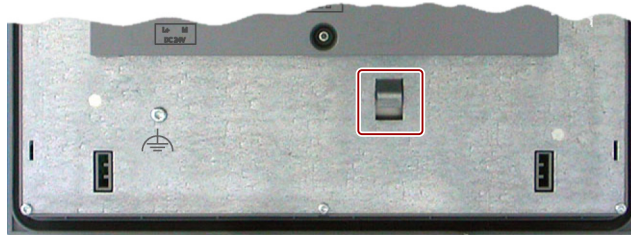

After the power-on test, use a cable tie to secure the connected cables to the marked fixing element in order to provide strain relief.

On the back of the HMI device KP400 Basic color PN, there are openings for leading in two cable ties for strain relief of the power supply cable and LAN cable.

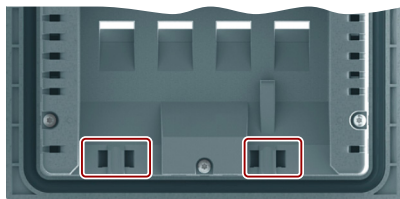

## Operating the device

### 4.1 Operating touch devices

#### 4.1.1 Overview

Most Basic HMI devices feature a touch screen. Certain Basic HMI devices feature function keys. Use the touch screen and function keys to operate the Control Panel or the project running on your HMI device.

#### DANGER

##### **Incorrect operation**

A project can contain certain operations that require in-depth knowledge about the specific plant on the part of the operator.

Ensure that only trained professional personnel operate the plant.

### Operating the touch screen

#### CAUTION

##### **Damage to the touch screen**

Pointed or sharp objects can damage the plastic surface of the touch screen.

Operate the touch screen only with your fingers or with a touch pen.

##### **Triggering unintended actions**

Touching several operating elements at the same time can trigger unintended actions.

Touch only one operating element on the screen at a time.

Operating elements are touch-sensitive symbols on the screen of the HMI device.

They are basically operated in the same way as mechanical keys. You activate operating elements by touching them with your finger.

---

**Note**

The HMI device returns a visual feedback as soon as it detects that an operating element has been touched.

The visual feedback is independent of any communication with the PLC. The visual feedback signal therefore does not indicate whether or not the relevant action is actually executed.

---

Examples of operating elements:

- Buttons

Buttons can assume the following states:



- Invisible buttons

The focus of invisible buttons is by default not indicated following selection. No optical operation feedback is provided in this case.

The configuration engineer may, however, configure invisible buttons so that their outline appears as lines when touched. This outline remains visible until you select another operating element.

- I/O fields

A screen keyboard appears as visual feedback after you touched an I/O field, for example, to enter a password.

Depending on the HMI device and the configured operating element, the system displays different screen keyboards for entering numerical or alphanumerical values.

The screen keyboard is automatically hidden again when input is complete.

---

**Note**

**Description of all operating elements**

A comprehensive description of all operating elements for your HMI device is provided in "Display and operating elements" section of the WinCC flexible and WinCC Online Help.

---

## Operating function keys

The function keys can be assigned global or local functions:

- Function keys with global function assignment

A function key with global function assignment always triggers the same action on the HMI device or in the PLC, regardless of the currently displayed screen. An example of such an action is the activation of a screen, or the closing of an alarm window.

- Function keys with local function assignment







A function key with local function assignment is screen-specific and is therefore only effective within the active screen.

The function assigned to a function key can vary from screen to screen.

The function key can be assigned only a single function, either global or local, within a screen. Local function assignments override global function assignments.

### 4.1.2 General functions of the screen keyboard

The following keys are available on the screen keyboard of all Basic HMI devices with touch functionality:

	Cursor left
	Cursor right
	Delete character
	Cancel input
	Confirm input
	Displaying infotext. This key only appears when an infotext has been configured for the operating element.



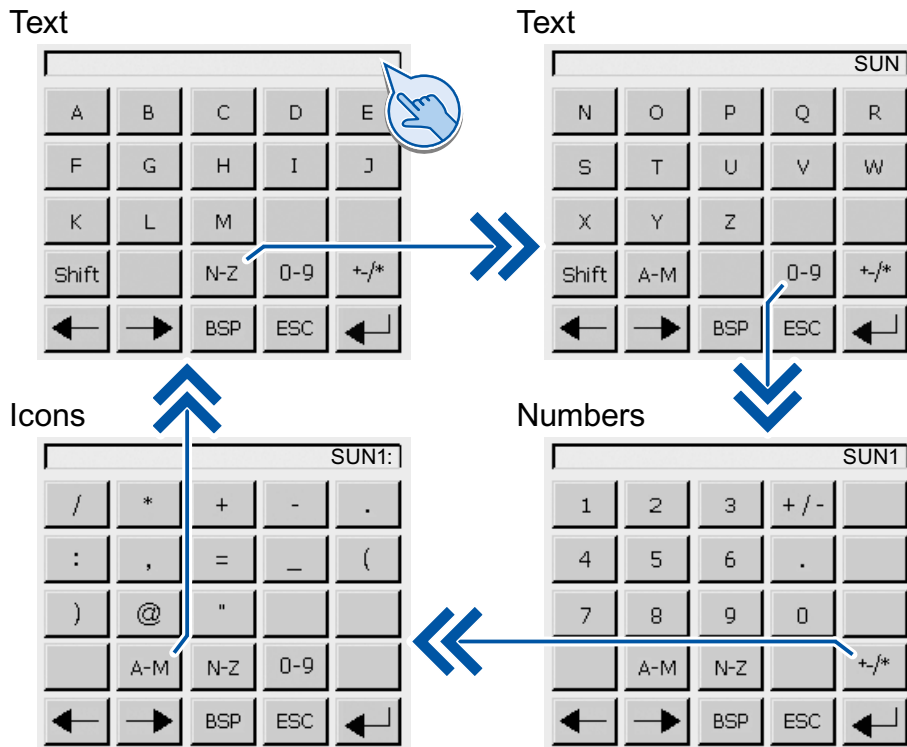

### 4.1.3 Entering data on the KTP400 Basic

Due to the small display, the screen keyboard and the input concept of the KTP400 Basic differs compared to other Basic HMI devices.



The screen keyboard appears on the HMI device touch screen when you touch an operating element that requires input.

The screen keyboard of the KTP400 BASIC features four views. You can change the view while making entries using the buttons in the fourth row of the screen keyboard:

Key	Changes to the view
	Entering text, characters "A" to "M"
	Entering text, characters "N" to "Z"
	Entering numbers, "0" to "9," signed or unsigned and with or without decimal places
	Entering special characters
	Entering text, shift to lower case letters

**Note**

**Job mailbox has no effect**

PLC job 51 "Select screen" has no effect while the screen keyboard is open.

**Key assignment**

The alphanumerical screen keyboard layout is monolingual.

A language change within the project has no effect on the layout of the alphanumerical screen keyboard.

**Entering alphanumerical values**

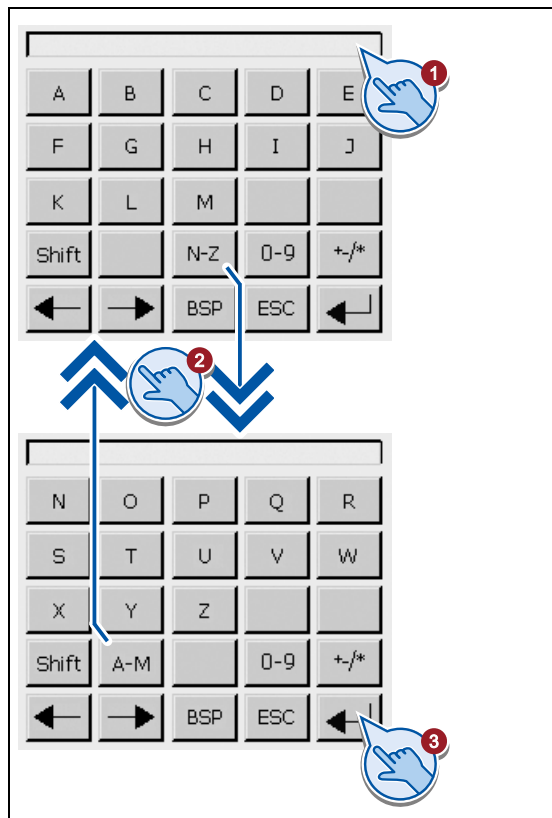

1. Touch the desired operating element on the screen.

The alphanumerical screen keyboard opens.

2. Enter the value. Depending on the settings, the HMI device outputs an audible signal.

You can change the view of the screen keyboard using the keys <N-Z> and <A-M>.

Use the <Shift> key to enter lower-case letters.

3. Press <Return> key to confirm your entries, or cancel them with <ESC>.

Either action closes the screen keyboard.

### Entering numerical values

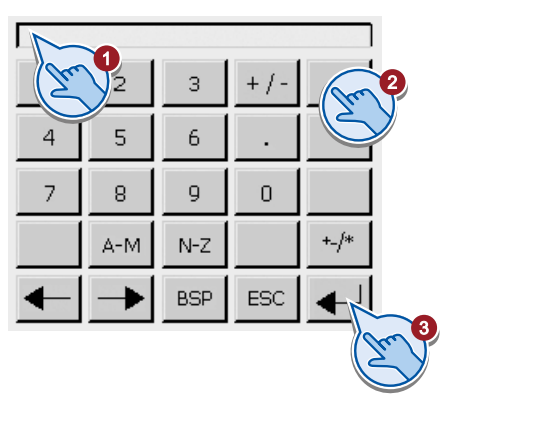
	<ol style="list-style-type: none"><li>1. Touch the desired operating element on the screen. The numerical screen keyboard opens.</li><li>2. Enter the value. Depending on the settings, the HMI device outputs an audible signal. You can change the view of the screen keyboard for entering numbers with hexadecimal notation using the &lt;N-Z&gt; and &lt;A-M&gt; keys.</li><li>3. Press &lt;Return&gt; key to confirm your entries, or cancel them with &lt;ESC&gt;. Either action closes the screen keyboard.</li></ol>
---	---

### Checking numerical value limits

Tags can be assigned limit values. Any entry of a value outside this limit is rejected. If an alarm view is configured, a system event is triggered and the original value is displayed again.

### Decimal places of numerical values

The configuration engineer can define the number of decimal places for a numerical text box. The number of decimal places is checked when you enter a value in this type of I/O field.

- Decimal places that exceed the limit are ignored.
- Unused decimal places are padded with "0" entries.



#### 4.1.4 Entering data on the KTP600 Basic, KTP1000 Basic , TP1500 Basic

##### Alphanumerical screen keyboard

The screen keyboard appears on the HMI device touch screen when you touch an operating element that requires input.

##### Text



##### Numbers



##### Note

##### Job mailbox has no effect

PLC job 51 "Select screen" has no effect while the screen keyboard is open.

##### Key assignment

The alphanumerical screen keyboard layout is monolingual.

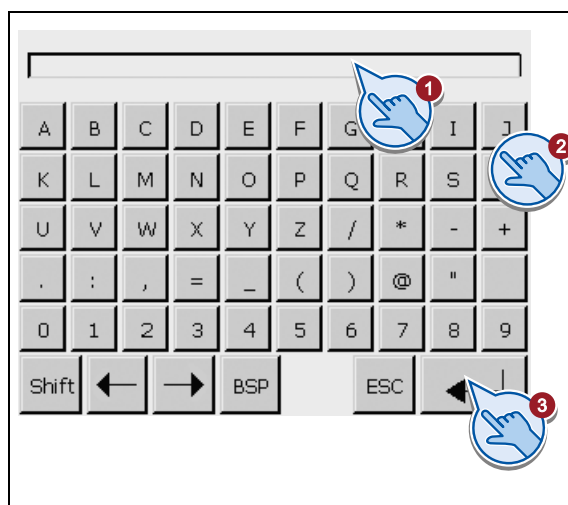

A language change within the project has no effect on the layout of the alphanumerical screen keyboard.

##### Entering alphanumerical values



1. Touch the desired operating element on the screen.  
The alphanumerical screen keyboard opens.
2. Enter the value. Depending on the settings, the HMI device outputs an audible signal.  
Use the <Shift> key to enter lower-case letters.
3. Press <Return> key to confirm your entries, or cancel them with <ESC>.  
Either action closes the screen keyboard.

### Entering numerical values

				
	1	2	3	ESC
B	4	5	6	BSP
C	7	8	9	+ / -
D	E	F	0	.
←	→	Help	←	

1. Touch the desired operating element on the screen.  
The numerical screen keyboard opens.

2. Enter the value. Depending on the settings, the HMI device outputs an audible signal.

3. Press <Return> key to confirm your entries, or cancel them with <ESC>.

Either action closes the screen keyboard.

### Checking numerical value limits

Tags can be assigned limit values. Any entry of a value outside this limit is rejected. If an alarm view is configured, a system event is triggered and the original value is displayed again.

### Decimal places of numerical values

The configuration engineer can define the number of decimal places for a numerical text box. The number of decimal places is checked when you enter a value in this type of I/O field.

- Decimal places that exceed the limit are ignored.
- Unused decimal places are padded with "0" entries.

## 4.2 Operating KP300 Basic









### 4.2.1 Overview

The KP300 Basic comes equipped with system keys. The system keys are as follows:

- Control keys
- Function keys with integrated alphanumeric keys

#### Control keys

The following table shows the function and effect of the control keys of the HMI device:

Key	Function	Effect
	Moving the cursor	Operating elements: Activates the next operating element in the respective direction Input: Moves the cursor in the respective direction List: Selects the next list entry.
	Confirming or activating	Menu: Executes the selected command. Input: Confirms and ends the entry. List: Activates the operation.
	Cancels the action	Value entry: Restores the original value. Window: Closes the window without applying a change. Help: Closes the Help and returns to the previous view.
	Acknowledge alarm	Depending on the configuration, acknowledges the currently displayed or selected message or all messages of an acknowledgment group.
	Delete characters	Deletes the character at the cursor position. The following characters are moved one position to the left.
	Displaying infotext	Shows the selected configured infotext for the selected operating element. No Help is displayed if no infotext is configured.
	Toggle between upper-case and lower-case	Toggles the text entry between upper-case and lower-case. The subsequent characters are then written either in upper or lower case.
	Activate next operating element	Activates the next operating element within the configured TAB order within the project.

### Operating function keys

The function keys can be assigned global or local functions:

- Function keys with global function assignment

A function key with global function assignment always triggers the same action on the HMI device or in the PLC, regardless of the currently displayed screen. An example of such an action is the activation of a screen, or the closing of an alarm window.

- Function keys with local function assignment

A function key with local function assignment is screen-specific and is therefore only effective within the active screen.

The function assigned to a function key can vary from screen to screen.

The function key can be assigned only a single function, either global or local, within a screen. Local function assignments override global function assignments.

<b>NOTICE</b>
<b>Function keys are disabled during keyboard input</b>
When you enter values using the keyboard, the function key assignment is disabled.
Take this information into account in your configuration.

Use the integrated alphanumeric keys for data input as described in the subsection below.

## 4.2.2 Entering data on the KP300 Basic

### Introduction

The function keys of the KP300 Basic have the same operating concept as a cell phone keypad. Each function key assigned with several letters and symbols of the alphabet and each is assigned a number. The available ones are displayed in a menu on the display when you enter values. The selection in the menu moves one position to the right every time the function key is pressed. At the end, the selection resumes again at the start.

The numerical and alphanumeric assignment always has the following order for value entry:

1. Letters, for example JKL
2. Numbers, for example 5
3. Special characters and umlauts (optional)

The following figure shows the assignment using the "F5" function key as an example.



- ① Number assignment; automatically active when you enter numerical values
- ② Function key assignment; active by default  
If you change to editing mode in the Control Panel or project with <ENTER>, the function assignment is disabled. Instead, the numerical and/or alphanumerical assignment is active. A message indicating that the function keys are disabled appears at the same time.
- ③ Letter assignment; automatically active when you enter alphanumerical values. The numerical assignment is available as well.  
When you enter hexadecimal values, the alphanumerical assignment from "A" to "F" and the numerical assignment are active.

On the KP300 Basic, you navigate either in the menu or operate the current project.

## Operating Menus

Proceed as follows:

1. Use the cursor keys to navigate within the menu of the KP300 Basic.  
The selection moves to the corresponding menu entry.
2. Press <ENTER> to execute a menu command.  
The next menu level is displayed.
3. If the menu level contains an text box, use the function keys to enter the appropriate value.
4. If the menu level contains a list:
  - Press <ENTER> to activate the operation of the list.
  - Use the cursor keys to move between list entries.
  - Press <ENTER> to execute a list entry.
5. To enter a value in the menu:
  - Press <ENTER> to apply a value.
  - Press <ESC> to discard a value or return to a higher-level menu.

### Operating a project

Proceed as follows:

1. To navigate between operating elements:
  - Press <TAB> to navigate within a configured TAB order.
  - Use the cursor keys to navigate freely between operating elements.The operating element is selected.
2. Press <ENTER> to activate the operation of a selected operating element.
  - Depending on the operating element, enter values or select them from the available list entries.
3. To close the operation of an operating element:
  - Press <ENTER> to apply any changes.
  - Press <ESC> to discard any changes.

### Entering numbers and characters

The function keys are used to enter numbers and characters.

Proceed as follows:

1. Activate the operation of the operating element.
2. Press the respective key repeatedly until the character you want appears on the screen.

The assignment of the function keys to letters and numbers can be restricted based on the format of the operating element.

The desired character is applied in about one second or immediately after pressing a different button.
3. To navigate within the given character string, use the cursor keys.
4. Press <ENTER> to apply the entry.

### Checking numerical value limits

Tags can be assigned limit values. Any entry of a value outside this limit is rejected. If an alarm view is configured, a system alarm is triggered and the original value is displayed again.

### Decimal places of numerical values

The configuration engineer can define the number of decimal places for a numerical text box. The number of decimal places is checked when you enter a value in this type of I/O field.

- Decimal places that exceed the limit are ignored.
- Unused decimal places are padded with "0" entries.

## 4.3 Operating KP400 Basic

### 4.3.1 Overview

#### Alphanumeric assignment of keys

















The following table shows the alphanumeric assignment of the data input keys.

Key	Alphanumeric assignment
1	.<space>_ \@#?!:;()€\$^~°{} 1
2	ABCÄÅ2
3	DEFË3
4	GHI4
5	JKL5
6	MNOÖ6
7	PRQRS7 for upper case letters, pqrsß7 for lower case letters
8	TUVÜ8
9	WXYZ9
0	+-*/=0
.	.,

#### General functions

You initiate functions either with keys or keyboard shortcuts. With keyboard shortcuts, hold the first key down. Then press the second key.





The following table shows the functions that are available both in the Control Panel and in the project:

Key or key combination	Function
	Switches between upper and lower case
	Deletes the character left of cursor.
	Moves to the next operating element in the TAB order.
 	Moves to the previous operating element in the TAB order.
	Deletes the character right of cursor. The following characters are moved one position to the left.
 	Inserts a space.
	<p>Cancels an action, e.g., cancel an input and close the dialog</p> <p>Value entry: Restores the original value.</p> <p>Window: Closes the window without applying a change.</p> <p>Help: Closes the Help and returns to the previous view.</p>
	<p>Executes a command, e.g.:</p> <ul style="list-style-type: none"> <li>• Operating buttons</li> <li>• Open dialog or select menu command</li> <li>• Check value, apply value after successful check and close the dialog</li> </ul>
	<p>Operating elements: Activates the next operating element in the respective direction</p> <p>Input: Moves the cursor in the respective direction</p> <p>List: Selects the next list entry.</p>
 	<p>Within a text box: Switches to the next or previous numerical or alphanumerical character</p> <p>Within a list: Selects the next list entry</p>
	Move the cursor or selection one screen up.
	Move the cursor or selection one screen down.
	Switches to another key mapping.





## Operating the Control Panel and dialogs

The following table shows additional key functions when operating the Control Panel and the associated dialogs.

Key or key combination	Function
	On tab level: Switches between tabs Within a text box: Positions the cursor
	Activates tab level, text boxes, buttons or options from top to bottom or from left to right
 	Activates tab level, text boxes, buttons or options from bottom to top or from right to left
	Selects or clears check boxes as well as the element of a radio button

## Operating a project

The following table shows additional key functions when operating an ongoing project.

Key or key combination	Function
	Acknowledges the currently displayed error alarm or all the alarms of an alarm group as group acknowledgment.
	Calls up the configured infotext for an operating element.

## Operating function keys

The function keys can be assigned global or local functions:

- Function keys with global function assignment

A function key with global function assignment always triggers the same action on the HMI device or in the PLC, regardless of the currently displayed screen. An example of such an action is the activation of a screen, or the closing of an alarm window.

- Function keys with local function assignment

A function key with local function assignment is screen-specific and is therefore only effective within the active screen.

The function assigned to a function key can vary from screen to screen.

The function key can be assigned only a single function, either global or local, within a screen. Local function assignments override global function assignments.

### 4.3.2 Entering data on the KP400 Basic

Data input on an HMI device is similar to operating the keys on a cell phone. Each key has several functions. When you press a data input key for long enough, the number is automatically inserted.

The following figure is an example for input of an alphanumeric value.

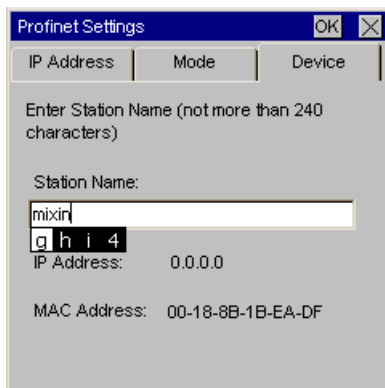

#### Requirement

The cursor must be in the text box.

#### Procedure

Proceed as follows:

1. Press the respective key repeatedly until the desired character is selected in the preview.  
The allocation of keys may be restricted to letters or numbers, depending on the context.  
The desired character is applied in about one second or immediately after pressing a different button.
2. To toggle between upper and a lower case, press <a/A>.



All subsequent characters are written either in upper or lower case.

3. To navigate within the given character string, use the cursor keys.
4. If you enter values in the Control Panel, you can apply them with <ENTER> or <TAB>:
  - <ENTER>: Closes the dialog.
  - <TAB>: Navigates to the next operating element within the dialog.
5. If you enter values in the project, you can apply them with <ENTER>.

## Configuring the HMI device

### 5.1 Configuring devices with graphical Control Panel

#### 5.1.1 Opening the Control Panel

With the exception of the KP300 Basic mono PN, all Basic Panels have a graphic Control Panel.

Open the Control Panel by pressing the "Control Panel" button of the Loader.

Configure your HMI device in the Control Panel. You can make the following settings:

- Communication settings
- Settings for operation
- Password protection
- Transfer settings
- Screen saver
- Acoustic signals

The "MPI / Profibus Settings" is only available on Basic Panels DP.

The "Profinet" is only available on Basic Panels PN.

The "Sound Settings" symbol is only available on devices with sound reproduction.

### Protecting the Control Panel with a password







You can protect the Control Panel against unauthorized operation. You can read the settings in the Control Panel without having entered a password, however, you are not allowed to edit the settings.

This prevents inadvertent operations and increases security for the plant or machine because the settings cannot be edited.

<b>NOTICE</b>
If the password is no longer available for the Control Panel, you first have to update the operating system before you can make any changes in the Control Panel.
All data on the HMI device is overwritten when you update the operating system.

### 5.1.2 Overview

The following table shows the functions available in the Control Panel for configuring your HMI device. Individual functions may be hidden, depending on the device type and device configuration.

Symbol	Function
	Changing MPI/DP settings (Page 69)
	Changing the network configuration (Page 70) Time server configuration (Page 71)
	Changing monitor settings (Page 72)
	Displaying information about the HMI device (Page 73)
	Calibrating the touch screen (Page 74)
	Displaying licensing information for the HMI device (Page 75)
	Changing password settings (Page 78)
	Enabling a data channel (Page 76)
	Setting the Screen Saver (Page 79)
	Setting acoustic signals (Page 79)

### 5.1.3 Changing MPI/DP settings

#### Note

The settings for MPI or PROFIBUS DP communication are defined in the HMI device project. Edit the transfer settings only in the following situations:

- Initial transfer of a project.
- Changes made to the project are activated at a later time.

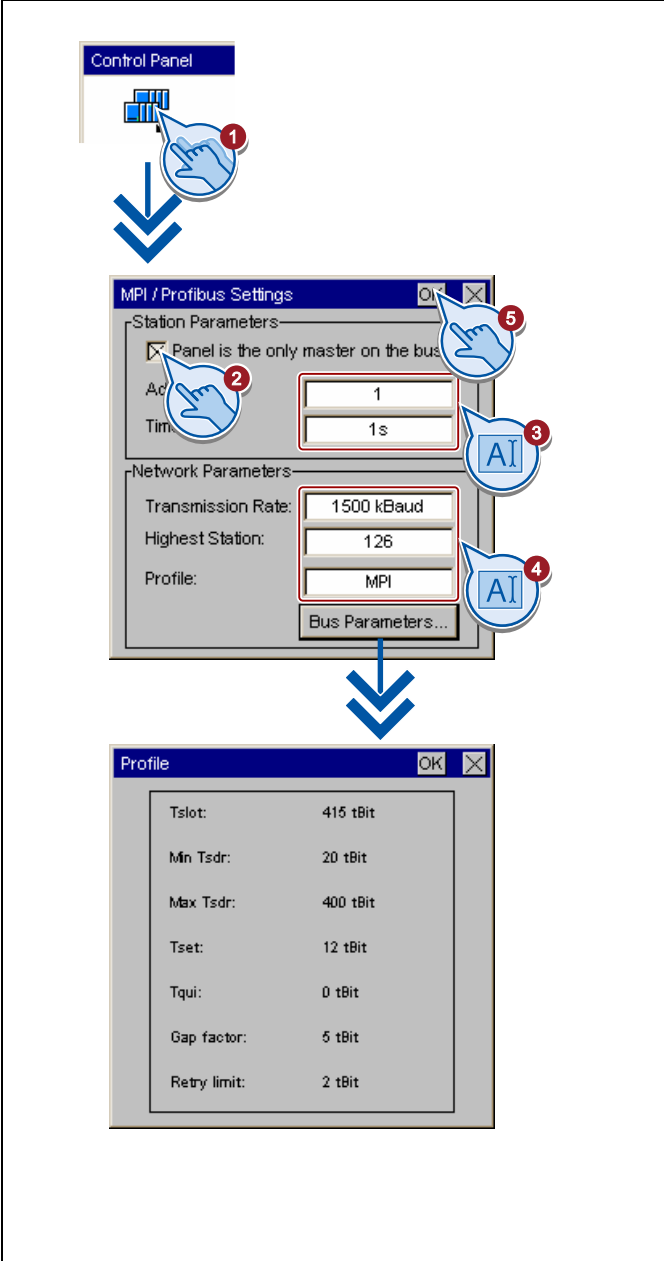

1. Press "MPI / Profibus Settings" to open the "MPI / Profibus Settings" dialog.
2. Deactivate the "Panel is the only master on the bus" check box if additional masters are connected to the bus.
3. Enter the bus address for the HMI device in the "Address" text box. The bus address must be unique within the MPI/PROFIBUS DP network.  
  
Enter the time limit for PROFIBUS communication in the "Time-out" text box. Valid values are 1 s, 10 s and 100 s.
4. Select the transmission rate from the "Transmission Rate" text box.  
  
Enter the highest station address on the bus in the "Highest Station" text box. Valid range of values: 1 to 126.  
  
Select the profile from the "Profile" selection box.  
  
Press the "Bus Parameters..." button to view the PROFIBUS profile data.
5. Close the dialog and save your entries with "OK".

### 5.1.4 Changing the network configuration

**NOTICE**

**Communication errors caused by IP address conflicts**

Communication errors can occur if several devices in a network share the same IP address.

Assign each HMI device an IP address that is unique within the network.

The image shows three sequential screenshots of the 'Profinet Settings' dialog box, illustrating the steps for configuring network settings:

- Step 1:** The 'Control Panel' icon is selected.
- Step 2:** The 'Specify an IP address' radio button is selected. The IP address is entered as 132.186.218.24, Subnet Mask as 255.255.255.0, and Default Gateway as 0.0.0.0.
- Step 3:** The 'Mode' tab is selected.
- Step 4:** The 'Speed' is set to 10 Mbits/s.
- Step 5:** The 'Half-Duplex' radio button is selected.
- Step 6:** The 'Auto Negotiation' checkbox is checked.
- Step 7:** The 'LLDP' checkbox is checked.
- Step 8:** The 'Deactivate LLDP' checkbox is checked.
- Step 9:** The 'Device' tab is selected.
- Step 10:** The 'Station Name' is entered.
- Step 11:** The 'OK' button is pressed to save the settings.

1. Press "Profinet" to open the "Profinet Settings" dialog.
2. Choose either automatic address assignment via DHCP, or user-specific address assignment.
3. If assigning a user-specific address, use the screen keyboard to enter valid values in the "IP Address", "Subnet Mask" text boxes and if applicable in the "Default Gateway" text box.
4. Open the "Mode" tab.
5. Enter the transmission rate for the PROFINET network in the "Speed" text box. Valid values are 10 Mbps and 100 Mbps.
6. Select "Half duplex" or "Full duplex" as the connection mode.
7. If the "Auto Negotiation" check box is selected, the transmission type and transmission rate in the PROFINET network will be automatically detected and set.
8. If the "Deactivate LLDP" check box is selected, the HMI device exchanges no information with other HMI devices.
9. Open the "Device" tab.
10. Enter a network name for your HMI device. The name must meet the following conditions.
  - Maximum length: 240 characters
  - Characters "a" to "z", numbers "0" to "9"; allow special characters: "-" and "."
  - Invalid syntax: "n.n.n.n" (n=0 to 999) and "port-xyz" (x, y, z =0 to 9)
11. Close the dialog and save your entries with "OK".

### 5.1.5 Time server configuration

The HMI device has an unbuffered realtime clock. The realtime clock is set either using the configuration or using a time server.

To fetch the time-of-day of the HMI device from a time server, specify up to four different time servers. The time-of-day is synchronized via the "Network Time Protocol" (NTP). Also specify the update cycle of the time-of-day and, if necessary, a time shift. Update cycle and time shift are valid for all configured time servers.

You can test the availability of each time server separately.

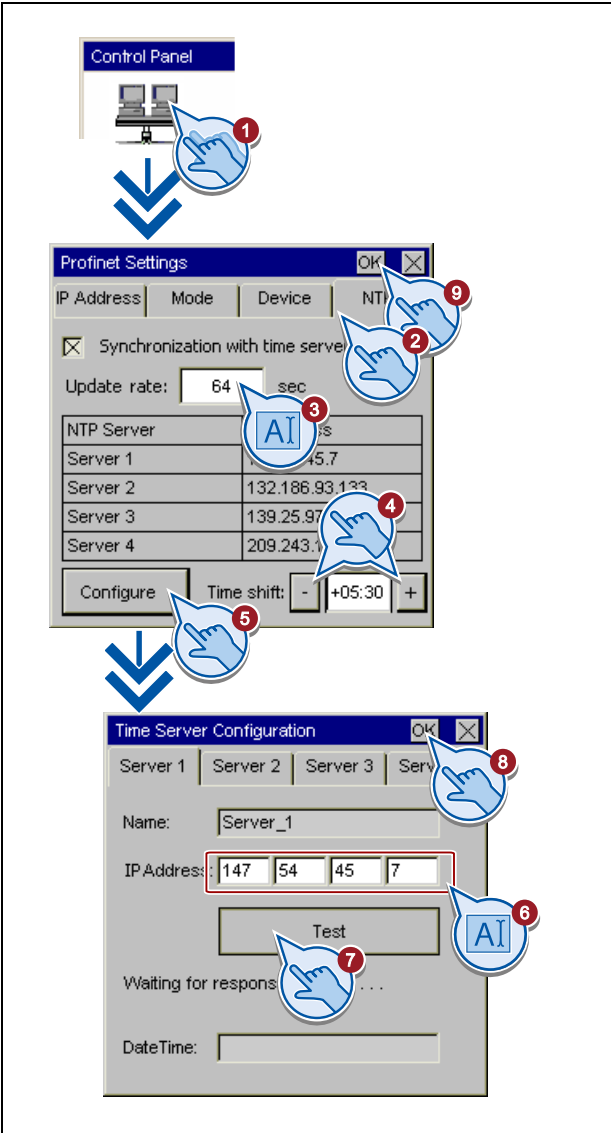

The image illustrates the configuration process for time servers on an HMI device. It shows two dialog boxes: 'Profinet Settings' and 'Time Server Configuration'. The 'Profinet Settings' dialog has tabs for 'IP Address', 'Mode', 'Device', and 'NTP'. The 'NTP' tab is active, showing a checked 'Synchronization with time server' option, an 'Update rate' of 64 seconds, and a table of four NTP servers. The 'Time shift' is set to +05:30. The 'Configure' button is highlighted. The 'Time Server Configuration' dialog shows the configuration for 'Server 1', with the IP address 147.54.45.7 entered and the 'Test' button highlighted.

1. Press "Profinet" to open the "Profinet Settings" dialog.
2. Open the "NTP" tab.
3. At "Update Rate", enter the time duration in seconds according to which the time-of-day will be synchronized.  
Value range: 10 to 86400 (1 day)
4. If required, use the "-" and "+" buttons to set the time shift in "±hh:mm".  
Value range: -24:00 to +24:00
5. Press "Configure" to open the configuration of the time server.
6. Enter the IP address of the time server at "IP Address".
7. Use the "Test" button to test the availability of the time server.  
The connection is established. If the connection was successfully established, date and time are displayed. Any value set at "Time shift" will not be taken into consideration.
8. Close the dialog and save your entries with "OK".
9. Close the dialog and save your entries with "OK".

### 5.1.6 Changing monitor settings

**NOTICE**

**Orientation of the screen for KTP400 Basic and KTP600 Basic**

The screen orientation is defined by the configuration engineer in the course of project creation. The appropriate screen orientation is set automatically when you transfer the project to the HMI device.

Do not make any changes to the screen orientation if a project exists on the HMI device. The screen content may otherwise be truncated.

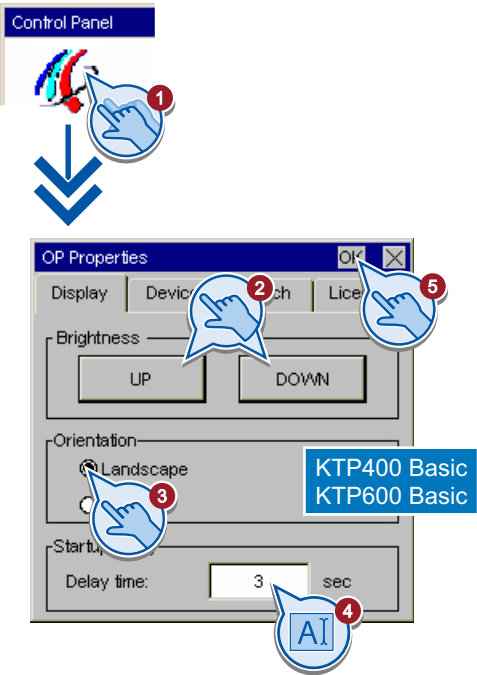

1. Press "OP" to open the "OP Properties" dialog.

2. Basic Panels Color (except KTP600 Basic color):  
Press the "UP" and "DOWN" buttons to adjust the screen brightness.  
Basic Panels mono:  
Press the "UP" and "DOWN" buttons to adjust the screen contrast.

3. KTP400 Basic and KTP600 Basic only:  
Select the screen orientation:  
– "Landscape" for landscape  
– "Portrait" for portrait

4. Set the delay time in the "Delay time" text box. The delay time in seconds defines the waiting time expiring between the appearance of the loader and the start of the project.  
Valid range of values: 0 s to 60 s.

5. Close the dialog and save your entries with "OK".

**Note**

**Immediate start of the project with a delay time of 0 seconds**

The project starts immediately if a delay time of 0 seconds is set. It is then no longer possible to call the Loader after switching on the HMI device. To handle this situation, you need to configure an operator control with the "Close project" function.



### 5.1.7 Displaying information about the HMI device

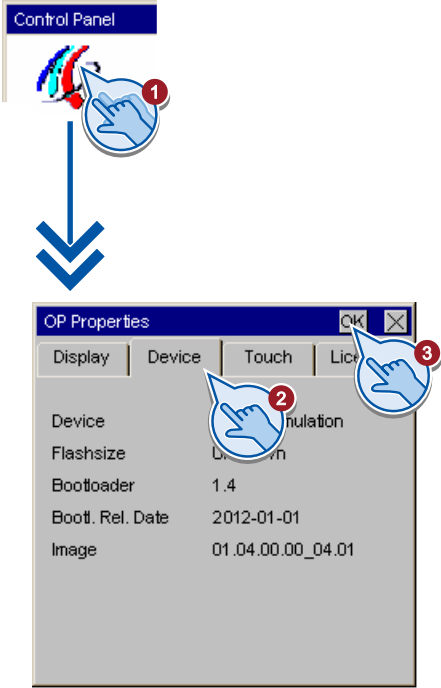

1. Press "OP" to open the "OP Properties" dialog.
  
2. Open the "Device" tab.
 

The "Device" tab is used to display specific information on the HMI device. You will need this information when contacting Technical Support.

  - "Device:" HMI device name
  - "Flashsize": Size of internal flash memory in which the HMI device image and project data are saved. The size of internal flash memory is not equivalent to application memory available for a project.
  - "Bootloader": Boot loader version
  - "Bootl. Rel. Date": Release date of the boot loader
  - "Image": Version of the HMI device image
  
3. Close the dialog with "OK."

### 5.1.8 Calibrating the touch screen

This function is only available for touch screen devices.

The diagram illustrates the calibration process in three stages:

- Control Panel:** A hand icon with a red '1' points to the 'Control Panel' icon.
- OP Properties Dialog:** A hand icon with a red '2' points to the 'Touch' tab, and another hand icon with a red '7' points to the 'OK' button.
- Recalibrate Screen:** A hand icon with a red '3' points to the 'Recalibrate' button.
- Calibration Screen:** A hand icon with a red '4' points to a floating cross in the center of the screen. A hand icon with a red '5' points to the corners of the screen. Text: "(Carefully press and briefly hold stylus on the center of the target. Repeat as the target moves around the screen.)"
- Confirmation Screen:** A hand icon with a red '6' points to the screen. Text: "New calibration settings have been measured. Tap the screen to register saved data. Wait for 30 seconds to cancel saved data and keep the current setting. Time limit: 30 sec"

1. Press "OP" to open the "OP Properties" dialog.
2. Change to the "Touch" tab.
3. Press "Recalibrate" to open the calibration screen.
4. Touch the cross in the screen center using the touch pen or your finger.
5. Using the touch pen or your finger, touch the floating cross in the corners of the screen.
6. Touch the cross in the screen center once again using the touch pen or your finger to confirm your entries.
7. Close the dialog and save your entries with "OK".

### 5.1.9 Displaying licensing information for the HMI device

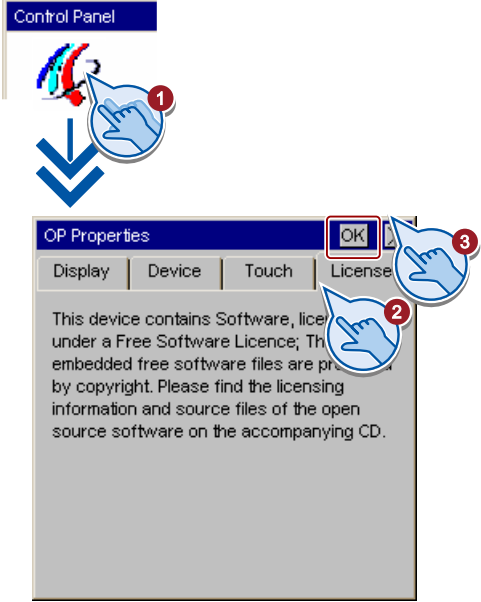
 <p>The diagram illustrates the process of displaying licensing information. It starts with a 'Control Panel' icon. A hand icon with a red '1' points to the 'OP' button. An arrow points down to the 'OP Properties' dialog box. Inside the dialog, a hand icon with a red '2' points to the 'License' tab. Another hand icon with a red '3' points to the 'OK' button.</p>	<ol style="list-style-type: none"> <li>1. Press "OP" to open the "OP Properties" dialog.</li> <li>2. Open the "License" tab. The "License" tab is used to display the licensing information for the software of the HMI device.</li> <li>3. Close the dialog with "OK."</li> </ol>
--	--

### 5.1.10 Enabling a data channel

You must enable at least one data channel to transfer a project to the HMI device.

#### Note

After having completed the project transfer, you can protect the HMI device against unintentional overwriting of project data and of the HMI device image by locking all data channels.

### Enabling a data channel - Basic Panels DP

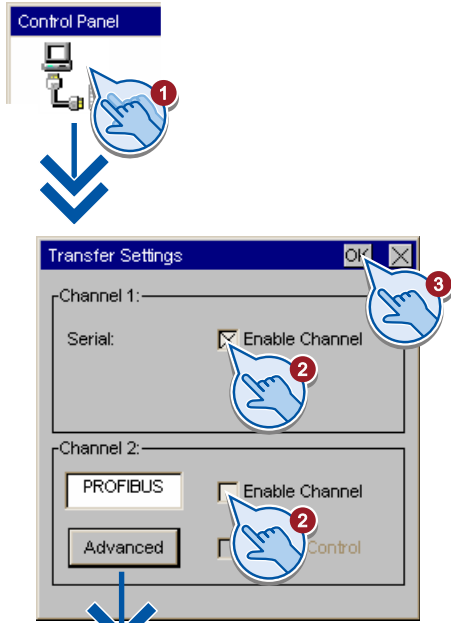
 <p>5.1.3</p>	<ol style="list-style-type: none"><li>1. Press "Transfer" to open the "Transfer Settings" dialog.</li><li>2. If the HMI device is interconnected with the configuring PC via PC-PPI cable, activate the "Enable Channel" check box in the "Channel 1" field.</li></ol> <p>If the HMI device is interconnected with a programming device via PROFIBUS, activate the "Enable Channel" check box in the "Channel 2" field.</p> <p>Press the "Advanced" button to open the "MPI / Profibus Settings" dialog. Verify the PROFIBUS parameters in this dialog. A description of the "MPI / Profibus Settings" dialog is provided in chapter 5.1.3, Changing MPI/DP settings (Page 69).</p> <ol style="list-style-type: none"><li>3. Close the dialog and save your entries with "OK".</li></ol>
---	--

#### Note

Automatic transfer is activated by setting the "Remote Control" check box. If automatic transfer is activated, the HMI device can be set remotely to transfer mode by a configuring PC or programming device.

## Enabling a data channel - Basic Panels PN

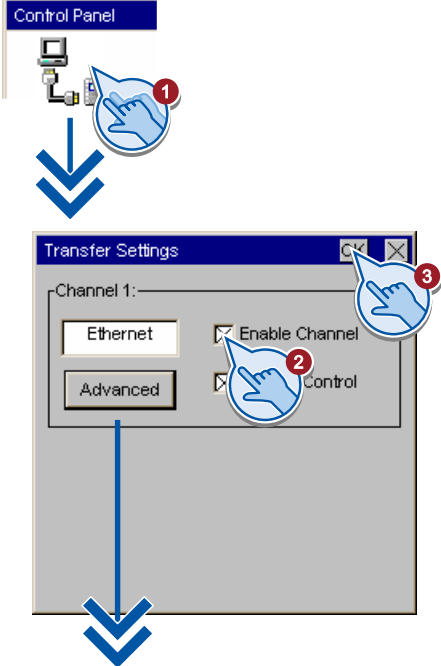
 <p>5.1.4</p>	<ol style="list-style-type: none"><li>1. Press "Transfer" to open the "Transfer Settings" dialog.</li><li>2. Select the "Enable Channel" check box in the "Channel 1" field.  Press the "Advanced" button to open the "Profinet Settings" dialog. Verify the network parameters in this dialog. A description of the "Profinet Settings" dialog is provided in chapter 5.1.4, Changing the network configuration (Page 70).</li><li>3. Close the dialog and save your entries with "OK".</li></ol>
---	--

**Note**

Automatic transfer is activated by setting the "Remote Control" check box. If automatic transfer is activated, the HMI device can be set remotely to transfer mode by a configuring PC or programming device.

### 5.1.11 Changing password settings

Password protection prevents unauthorized access to the Control Panel.

#### NOTICE

The password cannot contain spaces or special characters \* ? . % / \ ' " .

If the password is no longer available for the Control Panel, you first have to update the operating system before you can make any changes in the Control Panel. All data on the HMI device will be overwritten when you update the operating system.

#### Procedure – activating password protection

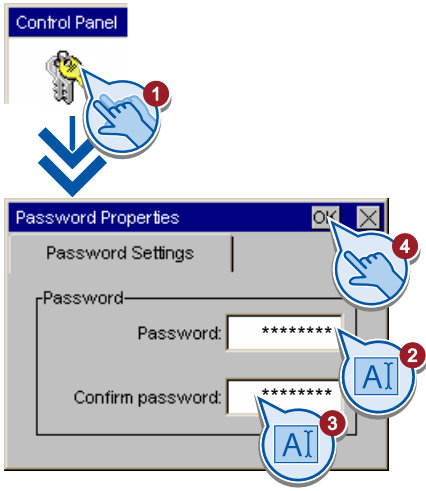
	<ol style="list-style-type: none"><li>1. Press "Password" to open the "Password Properties" dialog.</li><li>2. Enter a password in the "Password" text box. Touch the text box. The alphanumerical screen keyboard is displayed.</li><li>3. Confirm the password in the "Confirm Password" text box.</li><li>4. Close the dialog and save your entries with "OK".</li></ol>
--	---

#### Procedure – Deactivating password protection

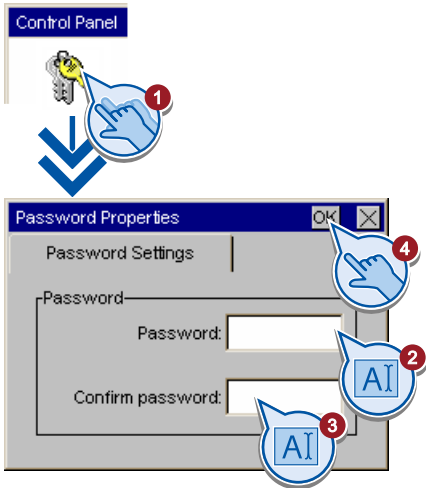
	<ol style="list-style-type: none"><li>1. Press "Password" to open the "Password Properties" dialog.</li><li>2. Delete the entries in the "Password" text box.</li><li>3. Delete the entries in the "Confirm Password" text box.</li><li>4. Close the dialog and save your entries with "OK".</li></ol>
---	--

### 5.1.12 Setting the Screen Saver

#### NOTICE

##### Burn-in effect

The screen contents may leave a faint version (ghost) of the image in the background if they appear for too long.

The "ghost" will disappear automatically after some time. The longer the same content is displayed on the screen, the longer it will take for the burn-in effect to disappear.

The screen saver helps to prevent burn-in.

Always use the screen saver.

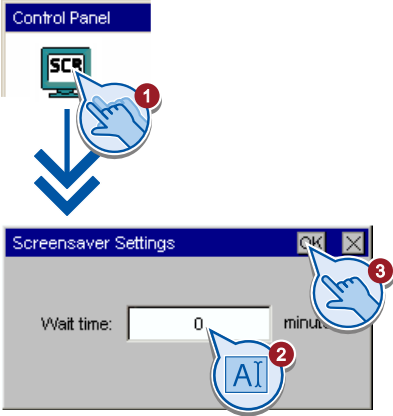
	<ol style="list-style-type: none"> <li>1. Press "Screensaver" to open the "Screensaver Settings" dialog.</li> <li>2. Enter the number of minutes before the screen saver is to be activated. Touch the text box to do this. You can enter values from 5 to 360 minutes. Entering "0" disables the screen saver.</li> <li>3. Close the dialog and save your entries with "OK".</li> </ol>
--	--

### 5.1.13 Setting acoustic signals

This function is only available for touch screen devices.

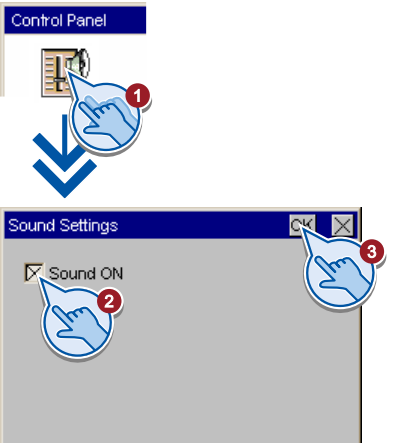
	<ol style="list-style-type: none"> <li>1. Press "Sound Setting" to open the "Sound Settings" dialog.</li> <li>2. Select the "Sound ON" check box. If the "Sound ON" check box is selected, you get acoustic feedback when you touch the touch screen.</li> <li>3. Close the dialog and save your entries with "OK".</li> </ol>
---	--

## 5.2 Configuring KP300 Basic

### 5.2.1 Opening the Control Panel

Use the "Info/Settings" menu command to open the Control Panel in the Loader.

Configure your HMI device in the Control Panel. You can make the following settings:

- Communication settings
- Settings for operation
- Password protection
- Transfer settings
- Screen saver

#### Protecting the Control Panel with a password

In the control panel you have the option of protecting the "Info Settings > Logon/Settings" menu with a password. The following menu entries continue to be freely accessible even when password protection is enabled:

- Transfer
- Start
- Info Settings > Contrast
- Info Settings > Device / Network / Version / License Info

This prevents inadvertent operations and increases security for the plant or machine because the settings cannot be edited.

<b>NOTICE</b>
If the password for the Control Panel is no longer available, you have to first update the operating system before you can make any changes in the Control Panel at "Info Settings > Logon/Settings".
All data on the HMI device is overwritten when you update the operating system!



## 5.2.2 Overview

The following table shows the menu structure of the Control Panel with the functions that are available there for configuring your HMI device.

Menu entry	Function / Note
Start	
Transfer	
Info/Settings	
Contrast	Changing monitor settings (Page 83)
[...] Info	Displaying information about the HMI device (Page 83)
Logon/Settings	
Startup Delay	Setting the Screen Saver (Page 88)
Value	
Screensaver	Changing monitor settings (Page 83)
Value	
Password	Changing password settings (Page 87)
Password	
Confirm Password	
Transfer/Network	
Channel 1: PROFINET	Enabling a data channel (Page 84)
Enable (rem. on)	
Enable (rem. on)	
Disabled	
IP Address/Station Name	Changing the network configuration (Page 85)
Station Name	
Station Name	
IP Address static or via DHCP	
IP via DHCP	
static IP	
IP Address	Only available if "static IP" is set.
Value	
Subnet Mask	Only available if "static IP" is set.
Value	
Def. Gateway	Only available if "static IP" is set.
Value	

			Network Mode	Changing the network configuration (Page 85)
			LLDP Protocol	
			Enable	
			Disable	
			Auto Negotiation	
			Enable	
			Disable	
			Speed	Only available if "Auto Negotiation = Enable"
			10 Mbits/s	
			100 Mbits/s	
			Communication Link	Only available if "Auto Negotiation = Enable"
			Half-Duplex	
			Full-Duplex	
			NTP	Time server configuration (Page 86)
			Synchronisation with time server	
			Enable	
			Disable	
			Server [1..4] IP Address	Only available if "Synchronisation with time server = Disable"
			Value	
			Test Server [1..4]	Only available if "Synchronisation with time server = Disable"
			DateTime	Shows date and time of the time server after a connection has been successfully established.
			Update rate	Duration in seconds according to which the time-of-day is synchronized.
			Value	
			Time shift	Time difference in "hh:mm"
			Value	

### 5.2.3 Displaying information about the HMI device

#### Menu commands in the "Info/Settings" menu

The following table shows the menu commands in the "Info/Settings" menu:

Menu item	Information contained there
Device Info	HMI device name Size of the internal flash memory in which the HMI device image and project are stored The size of internal flash memory is not equivalent to application memory available for a project.
Network Info	IP address, MAC address and name of the HMI device. If the name does not fit in a row, the name is abbreviated and marked with "...".
Version Info	Version of the HMI device image Version and release date of the Boot loader
License Info	License provisions

#### Procedure

Proceed as follows:

1. Switch to "Info/Settings" menu on the HMI device.
2. Select the desired menu command.
3. Press <ESC> or <ENTER> to go back to the higher-level menu.

### 5.2.4 Changing monitor settings

#### Procedure

Proceed as follows:

1. To change the contrast:
  - Switch to "Info/Settings > Contrast" menu on the HMI device.
  - User the cursor keys <Up> and <Down> to change the contrast and confirm with <ENTER>.
2. To enter the display time duration of the Loader prior to project start:
  - Switch to "Info/Settings > Logon/Settings > Startup Delay" menu on the HMI device.
  - Activate the list with <ENTER> and enter the display time duration in seconds.  
Value range: 0 to 60
  - Confirm with <ENTER>.

---

#### Note

##### Immediate start of the project with a delay time of 0 seconds

The project starts without delay if a delay time of 0 seconds is set. It is then no longer possible to call the Loader after switching on the HMI device. To handle this situation, you need to configure an operating element with the "Close project" function.

---

### 5.2.5 Enabling a data channel

You must enable at least one data channel to transfer a project to the HMI device.

---

#### Note

After having completed the project transfer, you can protect the HMI device against unintentional overwriting of project data and of the HMI device image by locking all data channels.

---

#### Procedure

Proceed as follows:

1. Switch to "Info/Settings > Logon/Settings > Transfer / Network" menu on the HMI device.
2. Using the <<Up> and <Down> cursor keys, select the desired mode under "Channel 1: PROFINET".
  - "Enable (rem.on)": Activates the data channel and also the automatic transfer
  - "Enable (rem.off)": Activates the data channel without automatic transfer
  - "Disable": Deactivates the data channel
3. Confirm the selection with <ENTER>.

---

#### Note

If automatic transfer is activated, the HMI device can be set remotely to transfer mode by a configuring PC or programming device.

---

## 5.2.6 Changing the network configuration

### NOTICE

#### Communication errors caused by IP address conflicts

Communication errors can occur if several devices in a network share the same IP address.

Assign each HMI device an IP address that is unique within the network.

### Procedure

Proceed as follows:

1. Switch to "Info/Settings > Logon/Settings > Transfer/Network > IP Address/Station Name" menu on the HMI device.
2. To enter a name for the HMI device, enter a name under "Station Name".

Rules for names:

- Not more than 240 characters
- Characters "a" to "z", numbers "0" to "9"; allow special characters: "-" and "."
- Invalid syntax: "n.n.n.n" (n=0 to 999) and "port-xyz" (x, y, z =0 to 9)

3. Select either automatic address assignment via DHCP or manual address assignment:
  - To acquire the IP address from a DHCP server, set the value under "IP address static or via DHCP" to "IP via DHCP"
  - To set a fixed IP address, set the value under "IP address static or via DHCP" to "static IP".

The entries "IP Address", "Subnet Mask" and "Def. Gateway" are also displayed in the "IP Address/Station Name" menu.

4. If you have assigned a static IP address, enter valid values under "IP Address", "Subnet Mask" and, if required, under "Def. Gateway".
5. Switch to "Info/Settings > Logon/Settings > Transfer/Network > Network Mode" menu on the HMI device.
6. If necessary, set the value under "LLDP Protocol" to "Enable".
7. Configure the settings for connection type and transmission rate:
  - To assign the connection type and transmission rate automatically, set the value under "Auto Negotiation" to "Enable".
  - To assign the connection type and transmission rate manually, set the value under "Auto Negotiation" to "Disable".

The entries "Speed" and "Communication Link" are also displayed in the "Network Mode" menu.

8. If you assign the connection type and transmission rate manually, select the desired values under "Speed" and "Communication Link".
  - Select "100 Mbps" or "10 Mbps".
  - Select "Half-Duplex" or "Full-Duplex".

## 5.2.7 Time server configuration

### Introduction

The HMI device has an unbuffered realtime clock. The realtime clock is set either using the configuration or using a time server.

To fetch the time-of-day of the HMI device from a time server, specify up to four different time servers. The time-of-day is synchronized via the "Network Time Protocol" (NTP). Also specify the update cycle of the time-of-day and, if necessary, a time shift. Update cycle and time shift are valid for all configured time servers.

You can test the availability of each time server separately.

### Procedure

Proceed as follows:

1. Switch to "Info/Settings > Logon/Settings > Transfer/Network > NTP" menu on the HMI device.

2. To activate the acquisition of a time-of-day from a time server, set the value under "Synchronisation with time server" to "Enable".

The menu entries "Server <Number> IP Address ", Test Server <Number>", "Update rate" and "Time shift" appear.

3. Enter the IP address of the time server under "Server <Number> IP Address ".
4. To test the availability of the time server, select the command "Test Server <Number>".

The connection is established. If the connection was successfully established, date and time are displayed. Any value set at "Time shift" will not be taken into consideration.

5. If required, configure additional time servers.
6. At "Update rate", enter the time duration in seconds according to which the time-of-day will be synchronized.

Value range: 10 to 86400 (1 day)

7. If required, enter the time shift in "±hh:mm" under "Time shift".

Value range: -24:00 to +24:00

## 5.2.8 Changing password settings

Password protection prevents unauthorized access to the "Info/Settings > Logon/Settings" menu.

### NOTICE

The password cannot contain spaces or special characters \* ? . % / \ ' " .

If the password for the "Info/Settings > Logon/Settings" menu is no longer available, you have to first update the operating system before you can make any changes in the "Info/Settings > Logon/Settings" menu. All data on the HMI device will be overwritten when you update the operating system.

### Activating password protection

Proceed as follows:

1. Switch to "Info/Settings > Logon/Settings > Password" menu on the HMI device.
2. Enter the password under "Password".
3. Confirm the password under "Confirm Password".
4. Exit the menu with <ENTER>.

### Deactivating password protection

Proceed as follows:

1. Switch to "Info/Settings > Logon/Settings > Password" menu on the HMI device.
2. Delete the password under "Password".
3. Confirm the (empty) password under "Confirm Password".
4. Exit the menu with <ENTER>.

## 5.2.9 Setting the Screen Saver

<b>NOTICE</b>
<b>Burn-in effect</b>
The screen contents may leave a faint version (ghost) of the image in the background if they appear for too long.
The "ghost" will disappear automatically after some time. The longer the same content is displayed on the screen, the longer it will take for the burn-in effect to disappear.
The screen saver helps to prevent burn-in.
Always use the screen saver.

### Procedure

Proceed as follows:

1. Switch to "Info/Settings > Logon/Settings > Screensaver" menu on the HMI device.
2. Enter the number of minutes before the screen saver is to be activated under "Value".  
Value range: 5 to 360; "0" deactivates the screen saver.
3. Confirm the entry with <ENTER>.



# Commissioning a project

## 6.1 Overview

### Configuration phase

A project – the process image of the working process – is created during configuration to visualize automated working processes. The process displays for the project contain displays for values and messages which provide information about process statuses. The process control phase follows the configuration phase.

### Process control phase

The project must be transferred to the HMI device if it is to be used in process control. Another precondition for process control is that the HMI device is connected online to a PLC. Current working processes - operating and observing - can then be subject to process control.

### Transferring the project to the HMI device

You can transfer a project to an HMI device as follows:

- Transfer from the configuring PC
- Restore from a PC using ProSave

In this case, an archived project is transferred from a PC to the HMI device. The configuration software need not be installed on this PC.

ProSave is a service tool that enables you to manage data on your HMI device. With ProSave, you can, for example, update the operating systems of the HMI device or backup its data.

### Commissioning and recommissioning

Initial and re-start-ups differ in the following respects:

- When the HMI device is commissioned there is no project at first.  
The HMI device is also in this state after the operating system has been updated.
- When recommissioning, any project already on the HMI device is replaced.

## 6.2 Operating modes

### Operating modes

The HMI device may be in the following operating modes:

- Offline
- Online
- Transfer

"Offline mode" and "Online mode" can be set on both the configuring PC and the HMI device. To set these modes on the HMI device, use a corresponding operating element of the project.

### Changing the operating mode

The configuration engineer must have configured an appropriate operating element to allow a change of the operating mode on the HMI device during ongoing operation.

Further information on this may be available in your plant documentation

### "Offline" operating mode

In this mode, there is no communication between the HMI device and PLC. Although the HMI device can be operated, it cannot exchange data with the PLC.

### "Online" operating mode

In this mode, the HMI device and PLC communicate. You can operate the plant on the HMI device according to your system configuration.

### "Transfer" mode

In this mode, you can transfer a project from the configuring PC to the HMI device or backup and restore HMI device data, for example.

The following options are available for setting "Transfer" mode on the HMI device:

- When the HMI device starts up

Start "Transfer" mode manually in the HMI device Loader.

- During ongoing operation

Start the "Transfer" mode manually within the project using an operating element. The HMI device toggles to "Transfer" mode when automatic mode is set and a transfer is initiated on the configuring PC.

## 6.3 Data transmission options

### Overview

The following table shows the options for data transfer between the HMI device and configuration PC.

Type	Data channel	Basic Panels DP	Basic Panels PN
Backup/restore, Operating system update	Serial <sup>1</sup>	Yes	-
	MPI/PROFIBUS DP	Yes	-
Project transfers	PROFINET	-	Yes
Updating the operating system with "Reset to factory settings"	Serial <sup>1</sup>	Yes	-
	MPI/PROFIBUS DP	-	-
	PROFINET	-	Yes

<sup>1</sup> Applies for operations with PC/PPI cable 6ES7 901-3CB30-0XA0 or USB/PPI cable 6ES7 901-3DB30-0XA0.

## 6.4 Transfer

### 6.4.1 Overview

Transfer the executable project from the configuration PC to the HMI device.

You can start the "Transfer" mode manually or automatically on the HMI device.

Transferred data is written directly to internal flash memory of the HMI device. Parameterize a corresponding data channel before you start the transfer.

### 6.4.2 Starting manual transfer

#### Introduction

You can manually switch the HMI device to "Transfer" mode as follows:

- At runtime, using a configured operating element.
- In the Loader of the HMI device.

#### Requirements

- The project is open in WinCC flexible or WinCC.
- The project is compiled.
- The HMI device is connected to a configuring PC.
- The data channel is configured on the HMI device.
- The HMI device is in "Transfer" mode.

### Procedure (WinCC flexible)

Proceed as follows:

1. On the configuring PC, select the "Transfer settings" command from the "Project > Transfer" menu in WinCC flexible.

The "Select devices for transfer" dialog opens.

2. Select the HMI device in the left area of the dialog.
3. Select the type of interconnection for the HMI device and the configuring PC.

Set the connection parameters.

4. Set the transfer parameters in the right area of the dialog.
5. Start the transfer in WinCC flexible by selecting "Transfer".

The configuring PC checks the connection to the HMI device. The project is transferred to the HMI device. An error message is displayed on the configuring PC if the connection is not available or disrupted.

### Procedure (WinCC)

If you are loading a project on an HMI device, the "Advanced loading" dialog is automatically opened. You configure the appropriate interface parameters in this dialog.

For further information, refer to the documentation on WinCC.

Proceed as follows:

1. If you want to load a project simultaneously on several HMI devices, use multiple selection to select all the desired HMI devices in the project tree.
2. Select the "Load to device > Software" command in the shortcut menu of an HMI device.
3. When the "Advanced loading" dialog appears, configure the "Settings for loading":
  - Select the interface via which the project will be loaded.
  - Configure the corresponding interface parameters.
  - Click on "Load".

You can open the "Advanced loading" dialog at any time via the menu command "Online > Advanced loading to device..."

The "Load preview" dialog opens. The entire project is compiled at the same time. The results is displayed in the "Load preview" dialog.

4. Check the displayed default settings, and edit these if necessary.
5. Click on "Load".

### Result

The project is available on the HMI device following successful transfer. The transferred project is started automatically.

## 6.4.3 Starting automatic transfer

### Introduction

If automatic transfer is activated, the HMI device automatically changes to "Transfer" mode at runtime as soon as a transfer is started on the connected configuring PC.

---

#### Note

With automatic transfer, the HMI device only changes into "Transfer" mode when the project is running on the HMI device.

---

Automatic transfer is particularly suited for the test phase of a new project since transfer is completed without interfering with the HMI device.

NOTICE
<p>If automatic transfer is activated on the HMI device and a transfer is initiated on the configuring PC, the project currently running is automatically stopped. The HMI device then automatically switches to "Transfer" mode.</p> <p>After the commissioning phase, deactivate the automatic transfer so that the HMI device cannot be inadvertently switched to transfer mode. Transfer mode can trigger unintentional actions in the plant.</p> <p>You can issue a password in the Control Panel to restrict access to the transfer settings and thus avoid unauthorized modifications.</p>

### Requirements

- The project is open in WinCC flexible or WinCC.
- The project is compiled.
- The HMI device is connected to a configuring PC.
- The data channel is configured on the HMI device
- The HMI device is in "Transfer" mode.
- The automatic transfer is activated in the data channel for the transfer
- The project is started on the HMI device.

### Procedure (WinCC flexible)

Proceed as follows:

1. On the configuring PC, select the "Transfer settings" command from the "Project > Transfer" menu in WinCC flexible.

The "Select devices for transfer" dialog opens.

2. Select the HMI device in the left area of the dialog.
3. Select the type of interconnection for the HMI device and the configuring PC.

Set the connection parameters.

4. Set the transfer parameters in the right area of the dialog.
5. Start the transfer in WinCC flexible by selecting "Transfer".

### Procedure (WinCC)

If you are loading a project on an HMI device, the "Advanced loading" dialog is automatically opened. You configure the appropriate interface parameters in this dialog.

For further information, refer to the documentation on WinCC.

Proceed as follows:

1. If you want to load a project simultaneously on several HMI devices, use multiple selection to select all the desired HMI devices in the project tree.
2. Select the "Load to device > Software" command in the shortcut menu of an HMI device.
3. When the "Advanced loading" dialog appears, configure the "Settings for loading":
  - Select the interface via which the project will be loaded.
  - Configure the corresponding interface parameters.
  - Click on "Load".

You can open the "Advanced loading" dialog at any time via the menu command "Online > Advanced loading to device..."

The "Load preview" dialog opens. The entire project is compiled at the same time. The results is displayed in the "Load preview" dialog.

4. Check the displayed default settings, and edit these if necessary.
5. Click on "Load".

### Result

The configuring PC checks the connection to the HMI device. The HMI device shuts down the current project and automatically changes to "Transfer" mode. The project is transferred to the HMI device. An error message is displayed on the configuring PC if the connection is not available or disrupted.

The project is available on the HMI device following successful transfer. The transferred project is started automatically.

## 6.4.4 Testing a project

### Introduction

You have the following options to test a project:

- Test the project on the configuring PC

You can test a project at a configuring PC, using a simulator. For detailed information, refer to the "WinCC flexible" user manual and to the WinCC flexible and WinCC Online Help.

- Offline testing of the project on the HMI device

Offline testing means that communication between the HMI device and PLC is down while the test is being carried out.

- Online testing of the project on the HMI device

Online testing means that the HMI device and PLC communicate with each other during testing.

Perform the tests, starting with the "Offline test", followed by the "Online test".

---

### Note

You should always test the project on the HMI device on which the project will be used.

---

Check the following:

1. Check the correct layout of the screens.
2. Check the screen navigation.
3. Check the input objects.
4. Enter the tag values.

The test ensures that the project will run as you intended on the HMI device.

### Requirements for offline testing

- The project has been transferred to the HMI device.
- The HMI device is in "Offline" mode.

### Procedure

In "Offline" mode, you can test individual project functions on the HMI device without them being affected by the PLC. PLC tags, therefore, are not updated.

Test the operator controls and visualization of the project as far as possible without connecting to the PLC.

### Requirements for online testing

- The project has been transferred to the HMI device.
- The HMI device is in "Online" mode.

### Procedure

In "Online" mode, you can test individual project functions on the HMI device without them being affected by the PLC. PLC tags are updated in this case.

You have the option to test all communication-dependent functions, for example alarms, etc.

Test the operator controls and views of the project.

## 6.5 Backup and restore

### 6.5.1 Overview

#### Backup and restore

You can back up and restore the following data in the internal flash memory of the HMI device with a PC:

- Project and HMI device image
- Password list
- Recipe data

Use one of the following tools for backup and restore:

- WinCC
- WinCC flexible
- ProSave

#### General information

<b>NOTICE</b>
<b>Power failure</b> If a complete restore operation is interrupted due to power failure on the HMI device, the operating system of the HMI device may be deleted. In this case, you have to reset the HMI device to its factory settings.
<b>Compatibility conflict</b> If a message is output on the HMI device warning of a compatibility conflict during the restore operation, the operating system must be updated.

---

**Note**

A data transfer can take several minutes, depending on data volume and transmission rate. Observe the status display. Do not interrupt the data transfer.

---



## See also

Data transmission options (Page 91)

## 6.5.2 Backup and restore using WinCC flexible

### Requirement

- No project is open on the configuration PC in WinCC flexible.
- The HMI device is connected to this configuration PC.
- The data channel is programmed on the HMI device.

### Procedure – backup

Proceed as follows:

1. On the configuration PC, select the "Communication settings" command in the menu "Project > Transfer" in WinCC flexible.  
The "Communication settings" dialog box opens.
2. Select the type of HMI device.
3. Select the type of connection between the HMI device and the configuration PC.  
Set the connection parameters.
4. Close the dialog with "OK".
5. Select the "Backup" command in the menu "Project > Transfer" in WinCC flexible.  
The "Backup settings" dialog opens.
6. Select the data to be backed up.
7. Select a destination folder and a file name for the "\*.psb" backup file.
8. Set "Transfer" mode on the HMI device.  
If automatic transfer mode is enabled on the HMI device, the HMI device automatically sets "Transfer" mode when a backup is initiated.
9. Start the backup operation in WinCC flexible with "OK" on the configuration PC.
10. Follow the instructions in WinCC flexible.  
A status view opens to indicate the progress of the operation.

### Result

The system outputs a message when the backup is completed.  
The relevant data is now backed up on the configuration PC.

### Procedure – restoring

Proceed as follows:

1. On the configuration PC, select the "Communication settings" command in the menu "Project > Transfer" in WinCC flexible.

The "Communication settings" dialog box opens.

2. Select the type of HMI device.
3. Select the type of connection between the HMI device and the configuration PC.
4. Set the connection parameters.
5. Close the dialog with "OK".

6. Select the "Restore" command in the menu "Project > Transfer" in WinCC flexible.

The "Restore Settings" dialog opens.

7. Select the "\*.psb" backup file to be restored from the "Open" field.

You can see the HMI device for which the backup file was created and the type of backup data the file contains.

8. Set "Transfer" mode on the HMI device.

If automatic transfer mode is enabled on the HMI device, the device automatically sets "Transfer" mode when a restore operation is initiated.

9. Start the restore operation in WinCC flexible with "OK" on the configuration PC.

Follow the instructions in WinCC flexible.

A status view opens to indicate the progress of the operation.

### Result

When the restore is successfully completed, the data backed up on the configuration PC is now on the HMI device.

### 6.5.3 Backup and restore using ProSave

#### Requirements

- The HMI device is connected to a PC on which ProSave is installed.
- The data channel is parameterized on the HMI device.

#### Procedure – backup

Proceed as follows:

1. Go to the Windows Start menu and start ProSave on the PC.
2. Select the HMI device type in the "General" tab.
3. Select the type of interconnection for the HMI device and the PC.  
Set the connection parameters.
4. Select the data to be backed up in the "Backup" tab.
  - "Complete backup" generates a backup copy of configuration data, recipe data and the HMI device image to a file in PSB format.
  - "Recipes" generates a backup copy of the HMI device's recipe data records in PSB format.
  - "Recipes (CSV format)" saves a backup copy of the HMI device's recipe data records to a text file in CSV format. The semicolon is used as column separator.
  - "User management" generates a backup copy of the HMI device's user data in PSB format.
5. Select the folder and file name for the \*.psb" backup file .  
When generating a backup copy of recipes in CSV format, only select a folder. A CSV file is generated for each recipe in this folder.
6. Set "Transfer" mode on the HMI device.  
If automatic transfer mode is enabled on the HMI device, the HMI device automatically sets "Transfer" mode when a backup is initiated.
7. Start the backup operation in ProSave with "Start Backup".  
Follow the instructions in ProSave.  
A progress bar opens to indicate the progress of the operation.

#### Result

The system outputs a message when the backup is completed.  
A backup copy of the data is now available on the PC.

### Procedure – restore

Proceed as follows:

1. Go to the Windows Start menu and start ProSave on the PC.
2. Select the HMI device type in the "General" tab.
3. Select the type of interconnection for the HMI device and the PC.
4. Set the connection parameters.
5. Select the "\*.psb" backup file to be restored from the "Restore" tab.

You can see the HMI device for which the backup file was created and the type of backup data the file contains.

Select one or several CSV files from the source folder to restore the recipes from CSV files.

6. Set "Transfer" mode on the HMI device.

If automatic transfer mode is enabled on the HMI device, the device automatically sets "Transfer" mode when a restore operation is initiated.

7. Start the restore operation in ProSave on the PC with "Start Restore".
8. Follow the instructions in ProSave.

A progress bar indicates the progress of the operation.

### Result

When the restore is successfully completed, the data backed up on the PC is now on the HMI device.

## 6.5.4 Backup and restore using WinCC

### Requirements

- The HMI device is connected to the configuring PC or the PC with ProSave
- The HMI device is selected in the project navigation.
- If a server is used for data backup: The HMI device has access to the server

### Backup of the data of the HMI device

Proceed as follows:

1. Select the "Backup" command from the "Online > HMI device maintenance" menu.  
The "SIMATIC ProSave" dialog box opens.
2. Select the data to backup for the HMI device under "Data type".
3. Enter the name of the backup file under "Save as".
4. Click "Start Backup".

This starts the data backup. The backup operation takes some time, depending on the connection selected.

## Restoring the data of the HMI device

Proceed as follows:

1. Select the "Restore" command from the "Online > HMI device maintenance" menu.
2. Enter the name of the backup file under "Save as".

Information about the selected backup file is displayed under "Content".

3. Click "Start Restore".

This starts the restoration. This operation takes some time, depending on the connection selected.

## 6.6 OS update - Basic Panel DP

### 6.6.1 Overview

#### Updating the operating system

A compatibility conflict may occur when transferring a project to the HMI device. This is caused by different versions of the configuration software used and the HMI device image available on the HMI device. If there are different versions, the transfer is aborted. A message indicating a compatibility conflict is displayed on the configuring PC.

There are two ways to match the versions:

- Update the HMI device image if the project was created with the most recent version of the configuration software.
- Transfer a matching version of the HMI device image if you do not want to adapt the project for the HMI device to the most recent version of the configuration software for the project.

<b>NOTICE</b>
<b>Data loss</b>
All data on the HMI device, such as the project and licenses, will be deleted when you update the operating system.

#### Note

##### Calibrating the touch screen

After the update, you may have to recalibrate the touch screen.

### 6.6.2 Resetting factory settings

In ProSave, WinCC flexible or WinCC, you can update the operating system with or without resetting to factory settings.

- Updating the operating system without reset to factory settings

First, switch into "Transfer" mode on the HMI device or use the automatic transfer function if the project is active. Then start the operating system update in ProSave, WinCC flexible or WinCC.

- Updating the operating system with reset to factory setting

<b>NOTICE</b>
<b>Data channel</b> When resetting to factory settings, all data channel parameters used are reset. The transfer can only be started following reconfiguration of the data channel.

**Note**

You have to perform an operating system update with reset to factory setting if the HMI device does not yet have an operating system or if the HMI device's operating system is corrupt.

First, start the operating system update in ProSave, WinCC flexible or WinCC, and switch the power on the HMI device off and on again when prompted.

**See also**

Data transmission options (Page 91)

### 6.6.3 Updating the Operating System using WinCC flexible

<b>CAUTION</b>
<b>Updating the operating system deletes all data on the HMI device</b> When you update the operating system you delete data on the target system. For this reason, it is advisable to backup the following data: <ul style="list-style-type: none"><li>• User administration</li><li>• Recipes</li></ul> Resetting to factory settings also deletes the License Keys. You should also back up the License Keys before resetting to factory settings.

## Requirements

- The HMI device is connected to a configuring PC.
- No project is open in WinCC flexible.
- When updating the operating system without reset to factory setting only:  
The data channel is configured on the HMI device.

## Procedure

Proceed as follows:

1. When updating the operating system with reset to factory setting only:  
Switch off power to the HMI device.
2. On the configuring PC, select the "Communication settings" command in the menu "Project > Transfer" in WinCC flexible.  
The "Communication Settings" dialog opens.
3. Select the type of HMI device.
4. Select the type of connection between the HMI device and the configuring PC, then set the connection parameters.
5. Close the dialog box with "OK".
6. Select the "OS Update" command from the "Project > Transfer" menu in WinCC flexible.
7. Select whether to update the operating system with or without restoring the factory settings by setting the "Reset to factory settings" check box accordingly.
8. Select the HMI device image file "\*.img" under "Image path".  
The HMI device image files are available under "WinCC flexible Images" in the WinCC flexible installation folder or on the WinCC flexible installation DVD.  
The output area provides information on the version of the successfully opened HMI device image file.
9. When updating without reset to the factory settings only:  
Set "Transfer" mode on the HMI device.  
If automatic transfer mode is enabled on the HMI device, the device automatically sets "Transfer" mode when an update is initiated.
10. In WinCC flexible, select "Update OS" on the configuring PC to run the operating system update.
11. When updating with reset to the factory settings only:  
Switch on the power supply to the HMI device.
12. Follow the instructions in WinCC flexible.  
A progress bar indicates the progress of the operating system update.

## Result

A message is displayed when the operating system update is successfully completed.  
The HMI device no longer contains any project data.

## 6.6.4 Updating the Operating System using ProSave

### Requirements

- The HMI device is connected to a PC on which ProSave is installed.
- When updating the operating system without reset to factory settings only:  
The data channel is configured on the HMI device.

### Procedure

Proceed as follows:

1. When updating the operating system with reset to factory settings only:  
Switch off power to the HMI device.
2. Go to the Windows Start menu and start ProSave on the PC.
3. Select the HMI device type in the "General" tab.
4. Select the type of connection between the HMI device and the PC, then set the connection parameters.
5. Select the "OS Update" tab.
6. Select whether to update the operating system with or without restoring the factory settings by setting the "Reset to factory settings" check box accordingly.
7. Select the HMI device image file "\*.img" under "Image path".

WinCC flexible: The HMI device image files are available under "WinCC flexible Images" in the WinCC flexible installation folder or on the installation CD.

WinCC: The HMI device image files are available under "Programme\Automation\Portal V11\Data\Hmi\Transfer\11.0\Images".

The output area provides information on the version of the successfully opened HMI device image file.

8. When updating without reset to the factory settings only:  
Set "Transfer" mode on the HMI device.  
  
If automatic transfer mode is enabled on the HMI device, the device automatically sets "Transfer" mode when an update is initiated.
9. Select "Update OS" on the PC to run the operating system update.
10. When updating with reset to the factory settings only:  
Switch on the power supply to the HMI device.
11. Follow the instructions in ProSave.  
A progress bar indicates the progress of the operating system update.

### Result

A message is displayed when the operating system update is successfully completed.

The HMI device no longer contains any project data.



## 6.7 OS update - Basic Panel PN

### 6.7.1 Overview

#### Updating the operating system

A compatibility conflict may occur when transferring a project to the HMI device. This is caused by different versions of the configuration software used and the HMI device image available on the HMI device. If there are different versions, the transfer is aborted. A message indicating a compatibility conflict is displayed on the configuring PC.

There are two ways to match the versions:

- Update the HMI device image if the project was created with the most recent version of the configuration software.
- Transfer a matching version of the HMI device image if you do not want to adapt the project for the HMI device to the most recent version of the configuration software for the project.

<b>NOTICE</b>
<b>Data loss</b>
All data on the HMI device, such as the project and licenses, will be deleted when you update the operating system.

#### Note

##### Calibrating the touch screen

After the update, you may have to recalibrate the touch screen.

---

### 6.7.2 Resetting factory settings

In ProSave, WinCC flexible or WinCC, you can update the operating system with or without resetting to factory settings.

- Updating the operating system without reset to factory settings

First, switch into "Transfer" mode on the HMI device or use the automatic transfer function if the project is active. Then start the operating system update in ProSave, WinCC flexible or WinCC.

- Updating the operating system with reset to factory setting

<b>NOTICE</b>
<b>Data channel</b>
When resetting to factory settings, all data channel parameters used are reset. The transfer can only be started following reconfiguration of the data channel.

**Note**

You have to perform an operating system update with reset to factory setting if the HMI device does not yet have an operating system or if the HMI device's operating system is corrupt.

First, start the operating system update in ProSave, WinCC flexible or WinCC, and switch the power on the HMI device off and on again when prompted.

**See also**

Data transmission options (Page 91)

### 6.7.3 Updating the operating system using WinCC flexible

If possible, you should use the interface with the highest bandwidth for this connection, such as Ethernet. Updating the operating system via a serial connection can take up to an hour.

<b>CAUTION</b>
<b>Updating the operating system deletes all data on the HMI device</b>
When you update the operating system you delete data on the target system. For this reason, it is advisable to backup the following data:
<ul style="list-style-type: none"><li>• User administration</li><li>• Recipes</li></ul>
Resetting to factory settings also deletes the License Keys. You should also back up the License Keys before resetting to factory settings.

## Requirements

- No project is open on the configuring PC in WinCC flexible.
- The HMI device is connected to this configuring PC.
- The data channel is configured on the HMI device.

## Procedure

Proceed as follows:

1. On the configuring PC, select the "Communication settings" command from the "Projekt > Transfer" menu in WinCC flexible.

The "Communication Settings" dialog opens.

2. Select the type of HMI device.
3. Select the type of interconnection for the HMI device and the configuring PC.
4. Set the connection parameters.
5. Close the dialog box with "OK".
6. In WinCC flexible, select the command "OS Update" from the "Projekt > Transfer" menu.
7. Select the HMI device image file "\*.img" under "Image path".

The HMI device image files are available under "WinCC flexible Images" in the WinCC flexible installation folder or on the WinCC flexible installation CD.

The output area provides information on the version of the successfully opened HMI device image file.

8. Switch into "Transfer" mode on the HMI device.  
If you have activated automatic transfer mode for the HMI device, the device automatically switches to "Transfer" mode when an update is initiated.
9. In WinCC flexible, select "Update OS" on the configuring PC to run the operating system update.
10. Follow the instructions in WinCC flexible.

A progress bar indicates the progress of the operating system update.

## Result

A message is displayed when the operating system update is successfully completed.  
The HMI device no longer contains any project data.

## 6.7.4 Updating the operating system using ProSave

### Requirements

- The HMI device is connected to a PC on which ProSave is installed.
- The data channel is configured on the HMI device.

### Procedure

Proceed as follows:

1. Go to the Windows Start menu and start ProSave on the PC.
2. Select the HMI device type in the "General" tab.
3. Select the type of connection between the HMI device and the PC.
4. Set the connection parameters.
5. Select the "OS Update" tab.
6. Select the HMI device image file "\*.img" under "Image path".

WinCC flexible: The HMI device image files are available under "WinCC flexible Images" in the WinCC flexible installation folder or on the installation CD.

WinCC: The HMI device image files are available under "Programme\Automation\Portal V11\Data\Hmi\Transfer\11.0\Images".

The output area provides information on the version of the successfully opened HMI device image file.

7. Switch into "Transfer" mode on the HMI device.

If you have activated automatic transfer mode for the HMI device, the device automatically switches to "Transfer" mode when an update is initiated.

8. Select "Update OS" on the PC to run the operating system update.
9. Follow the instructions in ProSave.

A progress bar indicates the progress of the operating system update.

### Result

A message is displayed when the operating system update is successfully completed.

The HMI device no longer contains any project data.

## 6.7.5 Updating the operating system using WinCC

If possible, you should use the interface with the highest bandwidth for this connection, such as Ethernet. Updating the operating system via a serial connection can take up to an hour.

### CAUTION

#### Updating the operating system deletes all data on the HMI device

When you update the operating system you delete data on the target system. For this reason, it is advisable to backup the following data:

- User administration
- Recipes

Resetting to factory settings also deletes the License Keys. You should also back up the License Keys before resetting to factory settings.

### Requirement

- The HMI device is connected to the configuring PC
- The appropriate data channel is configured on the HMI device.
- The HMI device is selected in the project navigation.

### Procedure

Proceed as follows:

Proceed as follows to update the operating system:

1. Select the "Update operating system" command from the menu under "Online > HMI device maintenance" on the configuring PC in WinCC.  
The "SIMATIC ProSave [OS-Update]" dialog opens. The path to the image of the operating system has been preset.
2. If necessary, select another path to the operating system image you want to transfer to the HMI device.
3. Click "Update OS".

### Result

This starts the update. The update operation can take time, depending on the connection selected.

## 6.7.6 Resetting to factory settings with WinCC flexible

### CAUTION

#### Updating the operating system deletes all data on the HMI device

When you update the operating system you delete data on the target system. For this reason, it is advisable to backup the following data:

- User administration
- Recipes

Resetting to factory settings also deletes the License Keys. You should also back up the License Keys before resetting to factory settings.

### Requirements

- No project is open on the configuring PC in WinCC flexible.
- The HMI device is connected to this configuring PC over the standard Ethernet cable.
- Have the MAC address of your HMI device's Ethernet interface to hand.
  - The MAC address is displayed briefly when the HMI device is turned on.
  - The MAC address is displayed in the "Profinet" dialog of the "Device" tab in the Control Panel.

### Procedure for setting the PC interface

1. Select "Start > Control Panel > Set PG / PC interface" on the configuring PC.
2. Select "S7ONLINE (STEP7) -> TCP / IP" from the "Application access point" area.
3. Select the interface which is connected to the HMI device from the "Interface parameterization used" area.
4. Confirm your entries.

### Procedure for resetting factory settings

Proceed as follows:

1. On the configuring PC, select the "Communication settings" command in the menu "Project > Transfer" in WinCC flexible.

The "Communication Settings" dialog opens.

2. Select the HMI device type from the "General" tab, and select "Ethernet" from the "Connection" area.
3. Enter an IP address.

---

**Note**

**Possible address conflicts with incorrect IP address**

Do not use a dynamic IP configuration for "Reset to factory settings".

Specify a unique IP address in which the configuring PC is located. For the duration of the update process, the HMI device is automatically assigned to the specified address.

If the HMI device has already been used with WinCC flexible or ProSave you can use the existing IP address for "Reset to factory settings".

---

4. Confirm your entries.
5. Select the "OS Update" command from the "Project > Transfer" menu in WinCC flexible.
6. Select the "Reset to factory settings" check box.  
A text box opens where you can enter the MAC address.
7. Enter the HMI device's MAC address in the text box.
8. Select the HMI device image file "\*.img" under "Image path".  
The HMI device image files are available under "WinCC flexible Images" in the WinCC flexible installation folder or on the WinCC flexible installation DVD.  
The output area provides information on the version of the successfully opened HMI device image file.
9. In WinCC flexible, select "Update OS" on the configuring PC to run the operating system update.
10. Follow the instructions in WinCC flexible on the configuring PC.  
A progress bar indicates the progress of the operating system update.

**Result**

A message is displayed when the operating system update is successfully completed. The HMI device no longer contains any project data. The factory settings are reset.

---

**Note**

If you can no longer open the Control Panel on the HMI device because the operating system is missing, carry out the above-described steps to reset the device to the factory settings, and try again.

---

**Note**

**Calibrating the touch screen**

When the restore operation has been completed, you may have to recalibrate the touch screen.

---

## 6.7.7 Resetting to factory settings with ProSave

### Requirement

- The HMI device is connected over the Ethernet to a PC on which ProSave is installed.
- Have the MAC address of your HMI device's Ethernet interface to hand.
  - The MAC address is displayed briefly when the HMI device is turned on.
  - Touch HMI devices: The MAC address is displayed in the "Profinet" dialog of the "Device" tab in the Control Panel.
  - KP300 Basic: The MAC address is displayed under "Info/Settings > Network Info".

### Procedure for setting the PC interface

1. Select "Start > Control Panel > Set PG / PC interface" on the configuring PC.
2. Select "S7ONLINE (STEP7) -> TCP / IP" from the "Application access point" area.
3. Select the interface which is connected to the HMI device from the "Interface parameterization used" area.
4. Confirm your entries.

### Procedure for resetting factory settings

Proceed as follows:

1. Go to the Windows Start menu and start ProSave on the PC.
2. Select the HMI device type from the "General" tab, and select "Ethernet" from the Connection area.
3. Enter an IP address.

---

#### Note

##### Possible address conflicts with incorrect IP address

Do not use a dynamic IP configuration for "Reset to factory settings".

Specify a unique IP address of the subnet in which the configuring PC is located. For the duration of the update process, the HMI device is automatically assigned to the specified address of ProSave.

If the HMI device has already been used with WinCC flexible or ProSave you can use the existing IP address for "Reset to factory settings".

---



4. Change to the "OS Update" tab.
5. Select the "Reset to factory settings" check box.  
A text box opens where you can enter the MAC address.
6. Enter the HMI device's MAC address in the text box.
7. Select the HMI device image file "\*.img" under "Image path".  
The HMI device image files are available under "WinCC flexible Images" in the WinCC flexible installation folder or on the WinCC flexible installation DVD.  
The output area provides information on the version of the successfully opened HMI device image file.
8. Select "Update OS" on the PC to start the "Reset to factory settings" process.
9. Follow the instructions in ProSave.  
A progress bar indicates the progress of the operating system update.

## Result

A message is displayed when the operating system update is successfully completed.  
The HMI device no longer contains any project data. The factory settings are reset.

---

### Note

If you can no longer open the Control Panel on the HMI device because the operating system is missing, carry out the above-described steps to reset the device to the factory settings, and try again.

---

### Note

#### Calibrating the touch screen

When the restore operation has been completed, you may have to recalibrate the touch screen.

---

## 6.7.8 Resetting to factory settings with WinCC

If possible, you should use the interface with the highest bandwidth for this connection, such as Ethernet. Updating the operating system via a serial connection can take up to an hour.

### CAUTION

#### Updating the operating system deletes all data on the HMI device

When you update the operating system you delete data on the target system. For this reason, it is advisable to backup the following data:

- User administration
- Recipes

Resetting to factory settings also deletes the License Keys. You should also back up the License Keys before resetting to factory settings.

---

### Note

The following is required to restore factory settings using Ethernet:

- MAC address of the HMI device
- Available IP address
- PG/PC interface of the configuring PC that is set to Ethernet TCP/IP

You configure the PG/PC interface using the Control Panel of the configuring PC. Select "S7ONLINE (STEP7) -> TCP/IP" under "Application access point".

---

### Requirements

- The HMI device is connected to the configuring PC
- The HMI device is selected in the project navigation.

### Resetting the HMI device to factory settings

To reset the HMI device to factory settings, proceed as follows:

1. Switch off power to the HMI device.
2. Select the "Update operating system" command from the menu under "Online > HMI device maintenance" on the configuring PC in WinCC.

The "SIMATIC ProSave [OS-Update]" dialog opens. The path to the image of the operating system has been preset.

3. If necessary, select another path to the operating system image you want to transfer to the HMI device.
4. Activate "Reset to factory settings".
5. Click "Update OS".
6. To "Reset to factory settings", switch on power to the HMI device again.

This operation can take time.

### Result

The operating system of the HMI device is now updated to the current version.

## Maintenance and care

### 7.1 Maintenance and care

#### Introduction

The HMI device is designed for maintenance-free operation. Make sure you keep the touch screen and keyboard membrane clean.

#### Requirements

Use a cleaning cloth dampened with a cleaning agent to clean the equipment. Only use water with a little liquid soap or a screen cleaning foam.

#### NOTICE

##### Unintentional response

When cleaning the touch screen, an unintentional response in the PLC can be triggered by touching keys.

Switch the HMI device off before cleaning to prevent unintentional responses.

##### Damage caused by unauthorized cleaning products

The HMI device may be damaged if compressed air, steam jet-air ejectors, aggressive solvents or scouring powders are used for cleaning purposes.

Do not clean the HMI device with compressed air or steam jet blowers. Do not use aggressive solvents or scouring powder.

#### Procedure

Proceed as follows:

1. Shut down the HMI device.
2. Spray the cleaning solution onto a cleaning cloth.  
Do not spray directly onto the HMI device.
3. Clean the HMI device.  
When cleaning the display wipe from the screen edge inwards.

## **7.2 Recycling**

### **Recycling and disposal**

The HMI devices described in these operating instructions can be recycled due to the low levels of pollutants. Contact a certified disposal service company for environmentally sound recycling and disposal of your old devices.

## Technical specifications

### 8.1 Certificates and approvals

#### Approvals

 <b>CAUTION</b>
<p>The following overview shows possible approvals.</p> <p>The HMI device itself is certified as shown on the rear panel labels.</p>

#### CE approval



The HMI device meets the general and safety-related requirements of the following EC directives and conforms to the harmonized European standards (EN) for programmable logic controllers published in the official gazettes of the European Union:

- 2004/108/EC "Electromagnetic Compatibility" (EMC Directive)

#### EC Declaration of Conformity

The EC Declarations of Conformity are available to the relevant authorities at the following address:

Siemens AG  
 Industry Sector  
 I IA AS FA WF AMB  
 PO Box 1963  
 D-92209 Amberg, Germany

#### Marking for Australia



The HMI device fulfills the requirements of standard AS/NZS 2064 (Class A).

#### UL approval



Underwriters Laboratories Inc., to

- UL 508 (Industrial Control Equipment)
- CSA C22.2 No. 142 (Process Control Equipment)

#### IEC 61131

The HMI device fulfills requirements and criteria to IEC 61131-2, Programmable Logic Controllers, Part 2: Operating resource requirements and tests.

## 8.2 Directives and declarations

### 8.2.1 Electromagnetic compatibility

#### Introduction

The HMI device fulfills, among other things, the requirements of the EMC law pertaining to the domestic European market.

#### EMC-compatible installation of the HMI device

The EMC-compliant installation of the HMI device and the application of interference-proof cable is the basis for interference-free operation. The "Directives for interference-free installation of PLCs" and the "PROFIBUS Networks" manual also apply for the installation of the HMI device.

#### Pulse-shaped disturbance

The following table shows the electromagnetic compatibility of modules with regard to pulse-shaped interference. The precondition for electromagnetic compatibility is that the HMI device meets the specifications and guidelines for electrical installation.

Pulse-shaped disturbance	Tested with	Degree of severity
Electrostatic discharge in accordance with IEC 61000-4-2	Air discharge: 8 kV Contact discharge: 6 kV	3
Burst pulses (high-speed transient interference) in accordance with IEC 61000-4-4	2 kV power supply cable 2 kV signal cable, > 30 m 1 kV signal cable, < 30 m	3
High-power surge pulses in accordance with IEC 61000-4-5, external protective circuit required (refer to the manual Automation System S7-300, Installation, "Lightning and overvoltage protection" section)		
Asymmetrical coupling	2 kV power cable DC voltage with protective elements 2 kV signal/data cable, > 30 m, with protective elements as required	3
Symmetrical coupling	1 kV power cable DC voltage with protective elements 1 kV signal cable, > 30 m, with protective elements as required	3

### Sinusoidal interference

The following table shows the EMC behavior of the modules with respect to sinusoidal interference. This requires the HMI device to meet the specifications and directives for electrical installation.

Sinusoidal interference	Test values	Degree of severity
HF radiation (in electromagnetic fields) in accordance with IEC 61000-4-3	<ul style="list-style-type: none"> <li>• 80% amplitude modulation at 1 kHz with 10 V/m in the range of 80 MHz to 1 GHz with 3 V/m in the range 1.4 GHz to 2 GHz with 1 V/m the range 2 GHz to 2.7 GHz</li> <li>• 10 V/m with 50% pulse modulation at 900 MHz 10 V/m with 50% pulse modulation at 1.89 GHz</li> </ul>	3
RF interference current on cables and cable shielding conforming to IEC 61000-4-6	Test voltage 10 V, with 80% amplitude modulation of 1 kHz in the 9 MHz to 80 MHz range	3

### Emission of radio interference

The following table shows the unwanted emissions from electromagnetic fields in accordance with EN 55011, Limit Value Class A, Group 1, measured at a distance of 10 m.

From 30 to 230 MHz	< 40 dB (µV/m) quasi-peak
From 230 to 1000 MHz	< 47 dB (µV/m) quasi-peak

#### Additional measures

To connect an HMI device to the public electric network, you must ensure its compliance with Limit Value Class B to EN 55022.

## 8.2.2 ESD guideline

### What does ESD mean?

An electronic module is equipped with highly integrated components. Due to their design, electronic components are highly sensitive to overvoltage and thus to the discharge of static electricity. Such electronic components or modules are labeled as electrostatic sensitive devices.

The following abbreviations are commonly used for electrostatic sensitive devices:

- ESD – Electrostatic sensitive device
- ESD – Electrostatic Sensitive Device as a common international designation

Electrostatic sensitive devices can be labeled with an appropriate symbol.



**CAUTION**

**Damage to ESD from touch**

Electrostatic sensitive devices, ESD, can be destroyed by voltages which are far below the human perception limit. If you touch a component or electrical connections of a module without discharging any electrostatic energy, these voltages may arise.

The damage to a module by an overvoltage can often not be immediately detected and only becomes evident after an extended period of operation. The consequences are incalculable and range from unforeseeable malfunctions to a total failure of the machine or plant.

Avoid touching components directly. Make sure that persons, the workstation and the packaging are properly grounded.

**Charge**

Every person without a conductive connection to the electrical potential of his/her surroundings can be electrostatically charged.

The material with which this person comes into contact is of particular significance. The figure shows the maximum electrostatic voltages with which a person is charged, depending on humidity and material. These values conform to the specifications of IEC 61000-4-2.

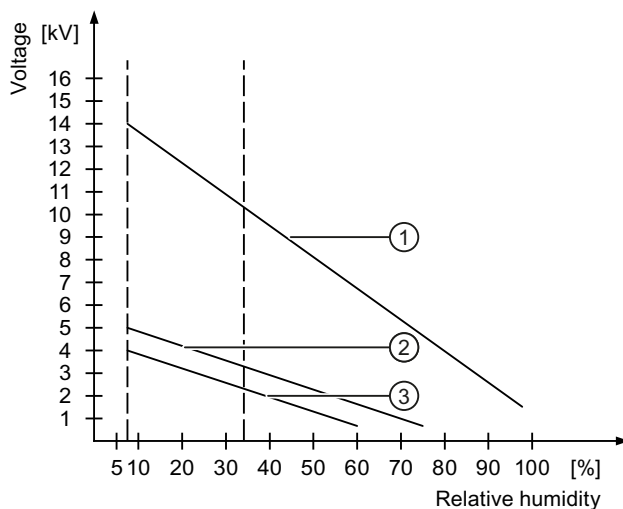

- ① Synthetic materials
- ② Wool
- ③ Antistatic materials such as wood or concrete



<b>CAUTION</b>
----------------

<b>Grounding measures</b>
---------------------------

There is no equipotential bonding without grounding. An electrostatic charge is not discharged and may damage the ESD.
--

Protect yourself against discharge of static electricity. When working with electrostatic sensitive devices, make sure that the person and the workplace are properly grounded.
---

### **Protective measures against discharge of static electricity**

- Disconnect the power supply before you install or remove modules which are sensitive to ESD.
- Pay attention to good grounding:
  - When handling electrostatic sensitive devices, make sure that persons, the workstation and devices, tools and packaging used are properly grounded. In this manner, you avoid static discharge.
- Avoid direct contact:
  - As a general rule, do not touch electrostatic sensitive devices, except in the case of unavoidable maintenance work.
  - Hold the modules at their edge so that you do not touch the connector pins or conductor paths. In this way, the discharge energy does not reach and damage the sensitive components.
  - Discharge your body electrostatically before you take a measurement at a module. Do so by touching grounded metallic parts. Always use grounded measuring instruments.

### 8.3 Dimension drawings

#### 8.3.1 Dimension drawing of the KP300 Basic mono PN

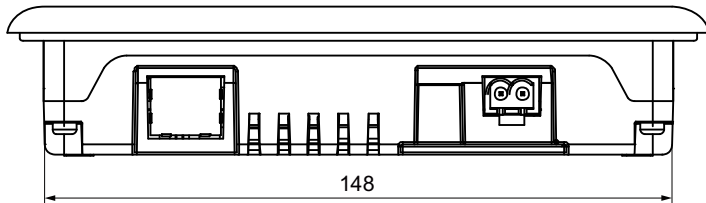

All dimensions in mm.

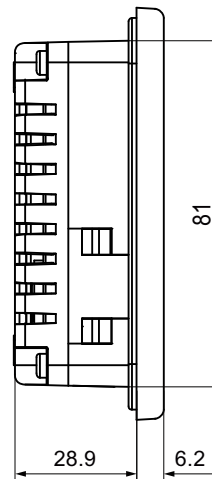
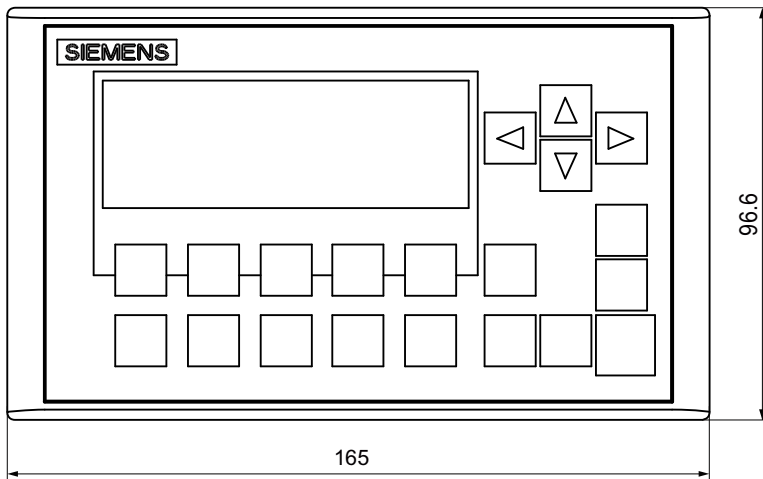

### 8.3.2 Dimension drawing of the KP400 Basic color PN

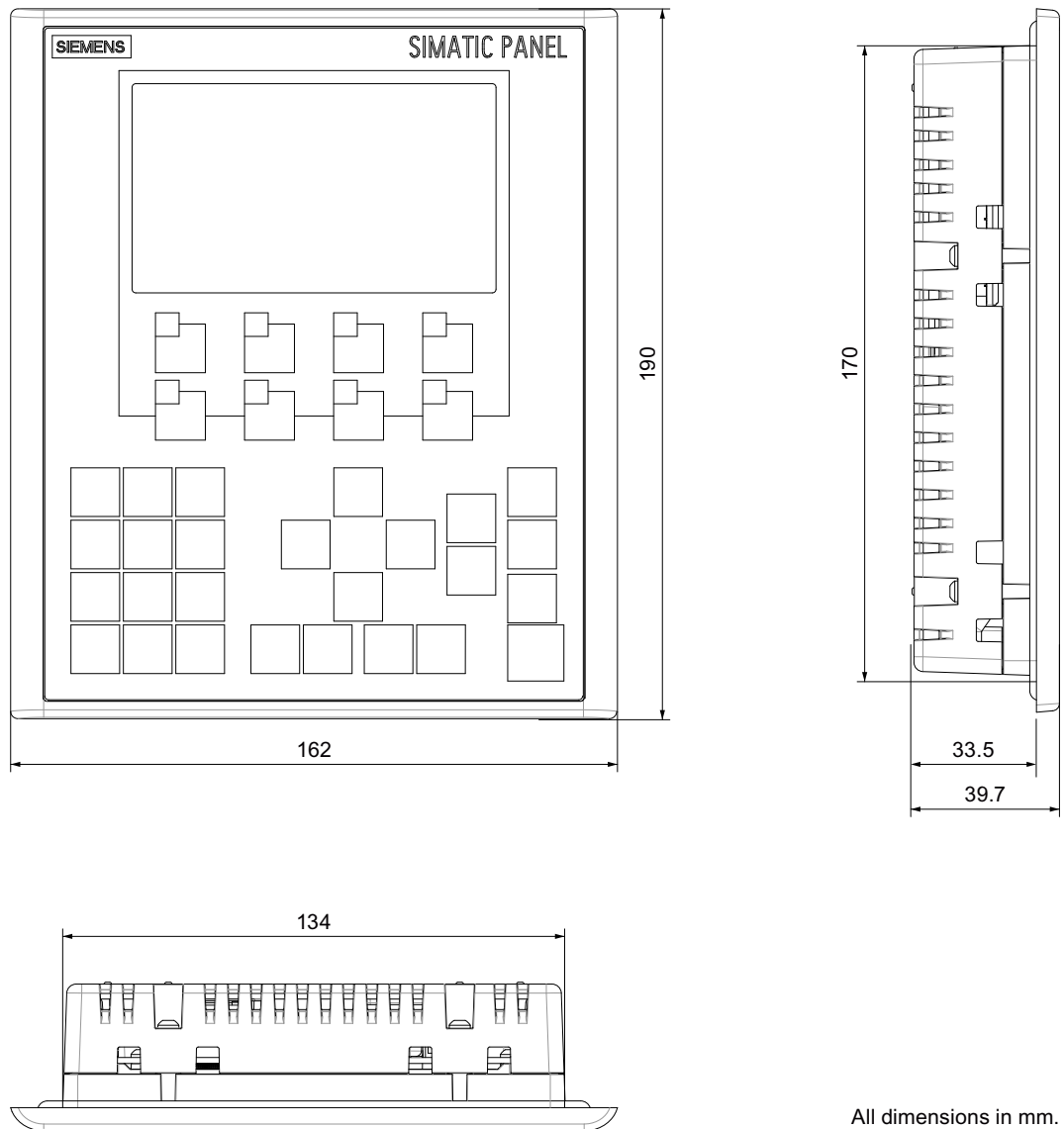

All dimensions in mm.

### 8.3.3 Dimension drawing of the KTP400 Basic mono PN

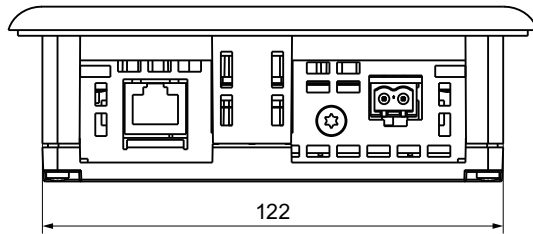

All dimensions in mm.

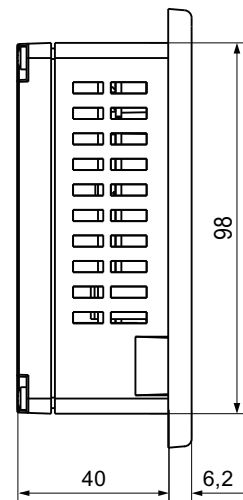
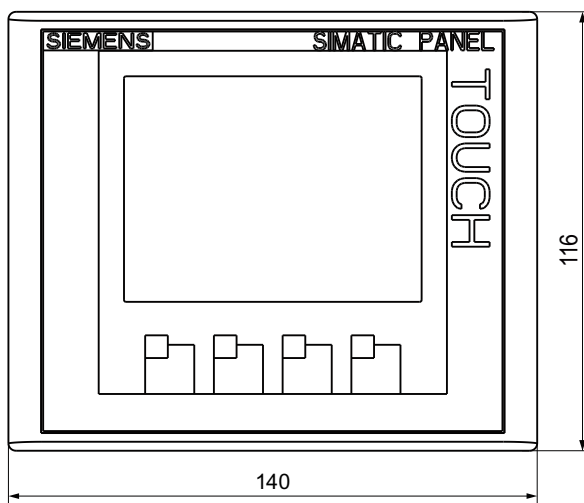

### 8.3.4 Dimension drawing of the KTP400 Basic color PN

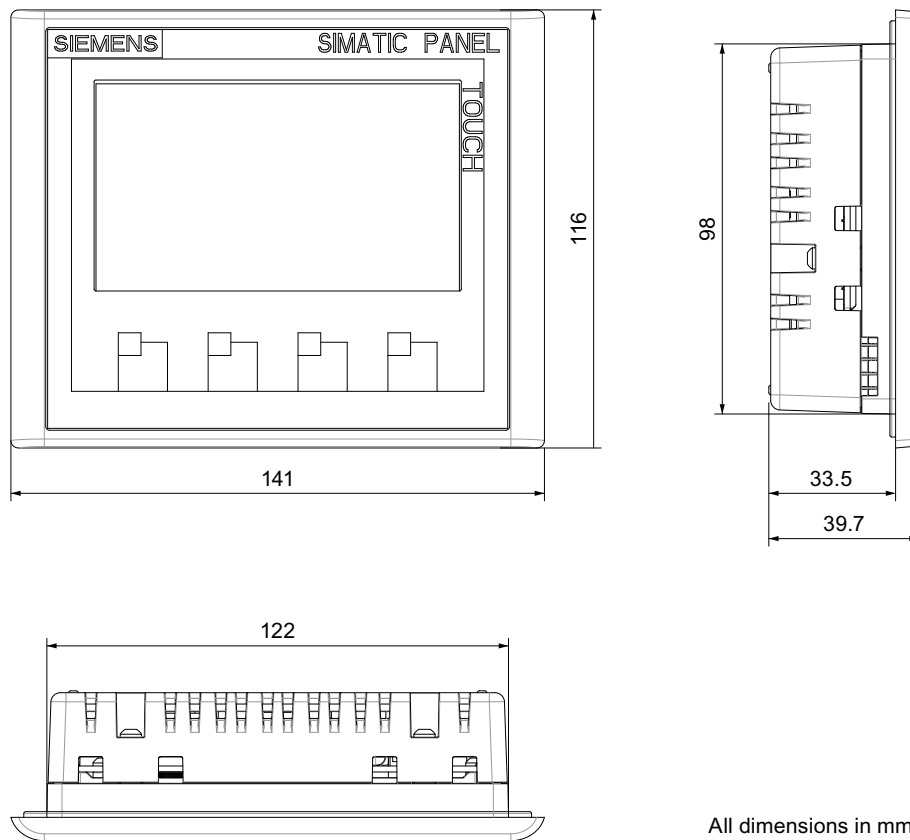

All dimensions in mm.

### 8.3.5 Dimension drawing of the KTP600 Basic color DP

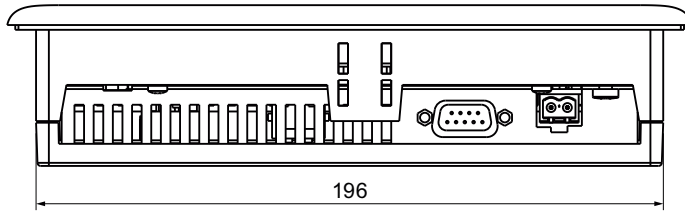

All dimensions in mm.

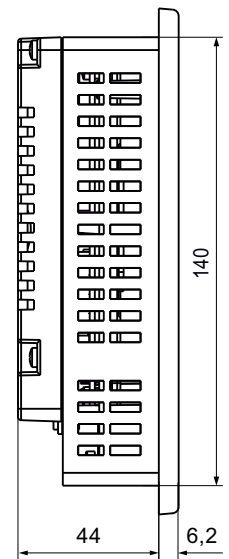
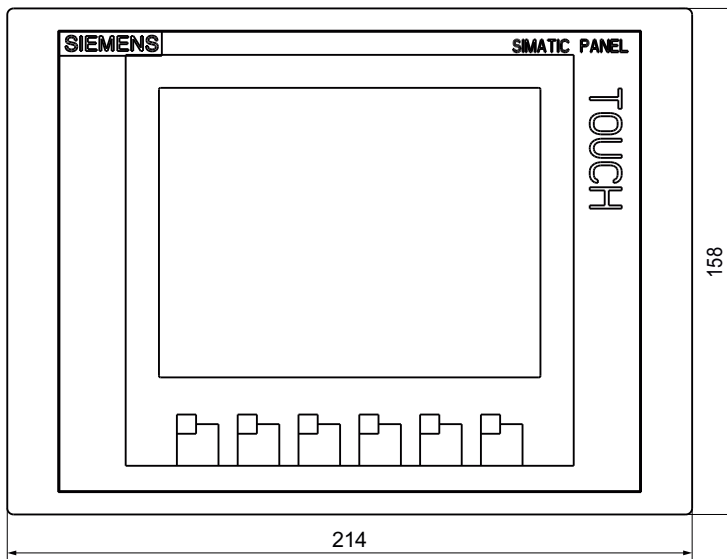

### 8.3.6 Dimension drawing of the KTP600 Basic mono/color PN

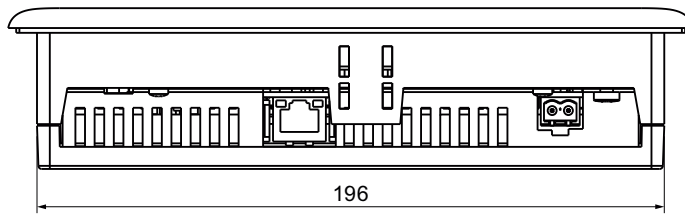

All dimensions in mm.

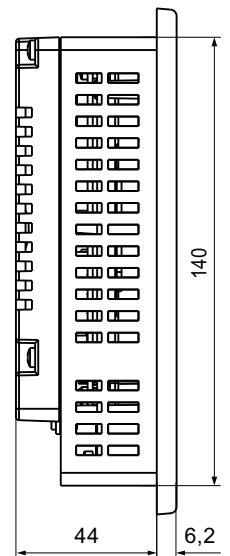
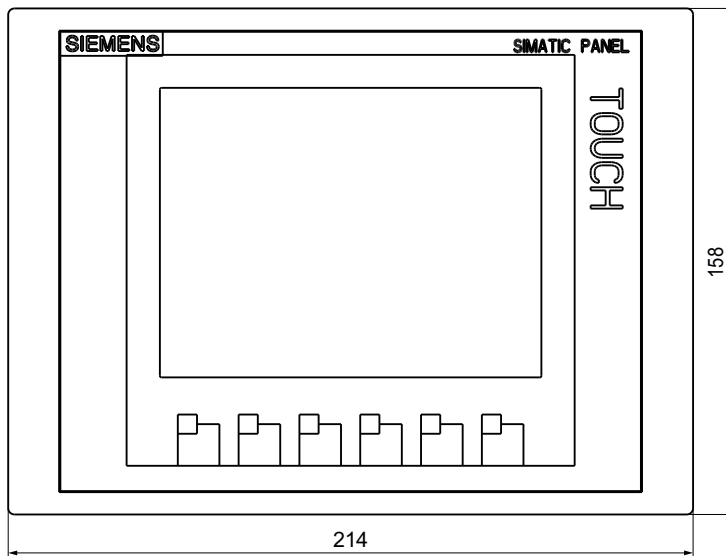

### 8.3.7 Dimension drawing of the KTP1000 Basic color DP

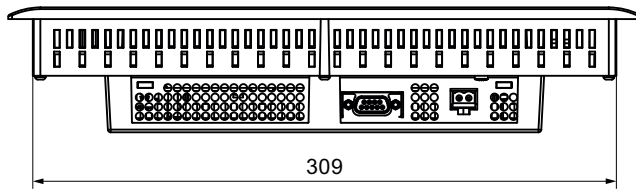

All dimensions in mm.

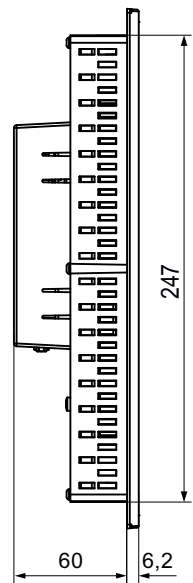
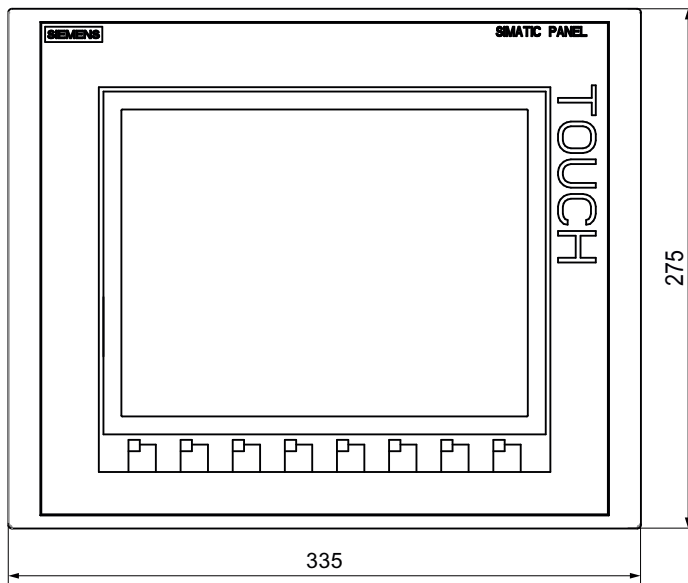



### 8.3.8 Dimension drawing of the KTP1000 Basic color PN

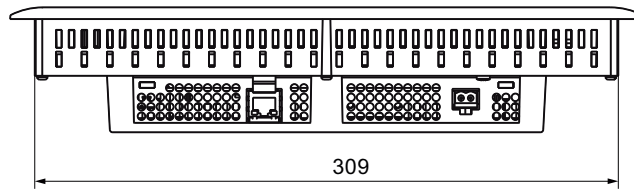

All dimensions in mm.

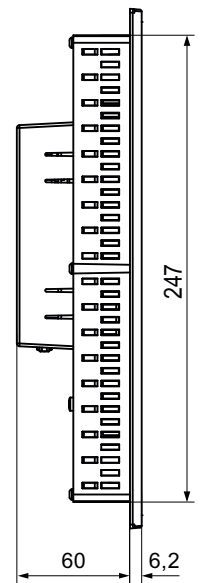
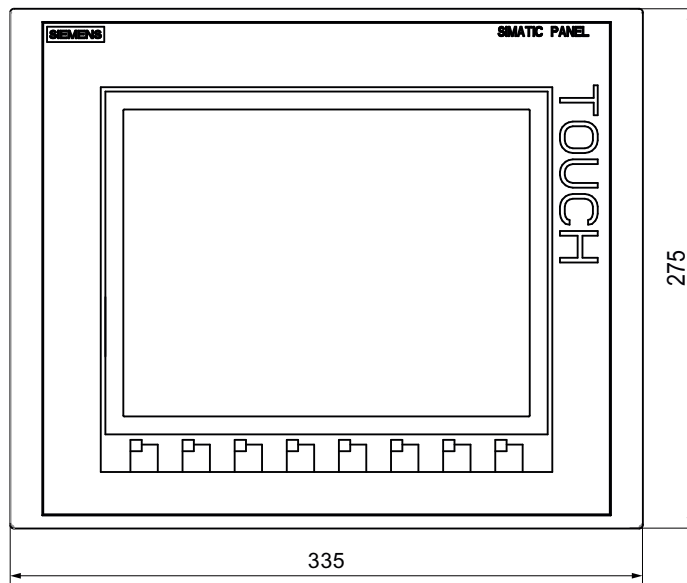

### 8.3.9 Dimension drawing of the TP1500 Basic color PN

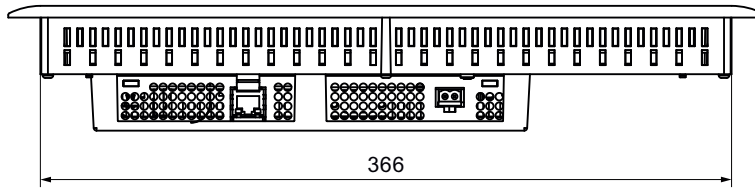

All dimensions in mm.

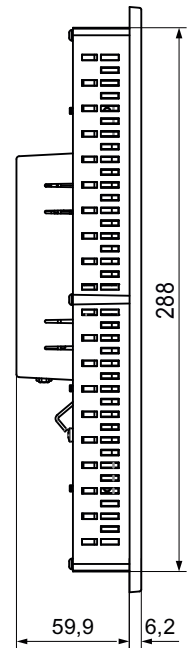
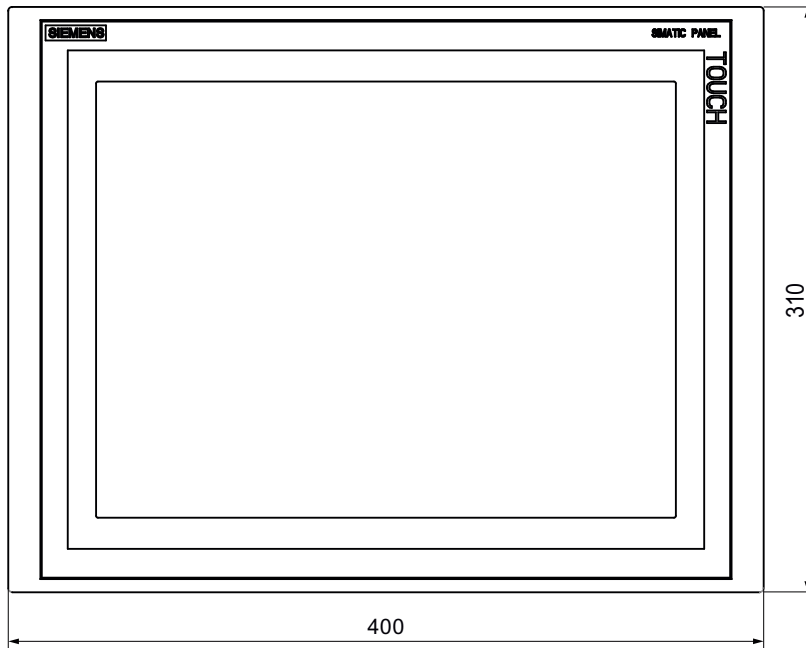

## 8.4 Specifications

### 8.4.1 Power supply

<b>CAUTION</b>
<b>Safe electrical isolation</b>
Use only 24 VDC power supply units with safe electrical isolation in accordance with IEC 60364-4-41 or HD 384.04.41 (VDE 0100, Part 410), e.g. to PELV standard.
The supply voltage must be within the specified voltage range. Otherwise, malfunction at the HMI device cannot be ruled out.
Applies to non-isolated plant configurations:
Connect the connection for GND 24 V from the 24 V power supply output to equipotential bonding for uniform reference potential. You should always select a central point of termination.

The following table shows the permitted rated voltage and the corresponding tolerance range.

Rated voltage	Tolerance range
+24 VDC	19.2 to 28.8 V (-20%, +20%)

### 8.4.2 KP300 Basic and KP400 Basic

#### Weight

	KP300 Basic mono PN	KP400 Basic color PN
Weight without packaging	Approx. 250 g	Approx. 510 g

#### Display

	KP300 Basic mono PN	KP400 Basic color PN
Type	LCD mono FSTN	LCD TFT
Active display area	87 x 31 mm (3.6")	95 x 53.8 mm (4.3")
Resolution	240 x 80 pixels	480 x 272 pixels
Possible colors	4 (only backlighting: white, red, green, yellow)	256
Contrast control	Yes	No
Brightness control	No	Yes

8.4 Specifications

	KP300 Basic mono PN	KP400 Basic color PN
Backlighting	LED	
Half Brightness Life Time (MTBF <sup>1</sup> )	50,000 h	
Pixel error class according to DIN EN ISO 13406-2	-	II

<sup>1</sup> MTBF: Operating hours after which the maximum brightness is reduced by half compared to the original value. MTBF is increased by using the integrated dimming function, for example, time-controlled via screen saver or centrally via PROFlenergy.

**Input device**

	KP300 Basic mono PN	KP400 Basic color PN
Type	Membrane keyboard	
Function keys	10	8
Labeling strips	No	Yes

**Memory**

	KP300 Basic mono PN	KP400 Basic color PN
Application memory	512 KB	1024 KB

**Interfaces**

	KP300 Basic mono PN	KP400 Basic color PN
1 x Ethernet RJ45	10/100 Mbps	

**Supply voltage**

	KP300 Basic mono PN	KP400 Basic color PN
Rated voltage	+24 V DC	
Range, permissible	19.2 to 28.8 V (-20%, +20%)	
Transients, maximum permissible	35 V (500 ms)	
Time between two transients, minimum	50 s	
Current consumption		
• Typical	Approx. 100 mA	Approx. 100 mA
• Constant current, maximum	Approx. 150 mA	Approx. 120 mA
• Inrush current I <sup>2</sup> t	Approx. 0.5 A <sup>2</sup> s	Approx. 0.5 A <sup>2</sup> s
Fuse, internal	Electronic	

**Miscellaneous**

	KP300 Basic mono PN	KP400 Basic color PN
Software clock, synchronizable	Yes	

### 8.4.3 KTP400 Basic and KTP600 Basic

#### Weight

	KTP400 Basic mono PN	KTP400 Basic color PN	KTP600 Basic mono PN	KTP600 Basic color DP	KTP600 Basic color PN
Weight without packaging	Approx. 320 g	Approx. 340 g	Approx. 1070 g		

#### Display

	KTP400 Basic mono PN	KTP400 Basic color PN	KTP600 Basic mono PN	KTP600 Basic color DP	KTP600 Basic color PN
Type	LCD mono FSTN	LCD TFT	LCD mono FSTN	LCD TFT	
Active display area	76.8 x 57.6 mm (3.8")	95 x 53.8 mm (4.3")	115.2 mm x 86.4 mm (5.7")		
Resolution	320 x 240 pixels	480 x 272 pixels	320 x 240 pixels		
Possible colors	4 grayscales	256	4 grayscales	256	
Contrast control	Yes	No	Yes	No	
Brightness control	No	Yes	No	No	
Backlighting	LED	LED	CCFL		
Half Brightness Life Time (MTBF <sup>1</sup> )	30,000 h	50,000 h	50,000 h		
Pixel error class according to DIN EN ISO 13406-2	-	II	-	II	

<sup>1</sup> MTBF: Operating hours after which the maximum brightness is reduced by half compared to the original value. MTBF is increased by using the integrated dimming function, for example, time-controlled via screen saver or centrally via PROFInergy.

#### Input device

	KTP400 Basic mono PN	KTP400 Basic color PN	KTP600 Basic mono PN	KTP600 Basic color DP	KTP600 Basic color PN
Type	Touch screen, analog resistive				
Function keys	4		6		
Labeling strips	Yes				

#### Memory

	KTP400 Basic mono PN	KTP400 Basic color PN	KTP600 Basic mono PN	KTP600 Basic color DP	KTP600 Basic color PN
Application memory	512 KB				

8.4 Specifications

**Interfaces**

	KTP400 Basic mono PN	KTP400 Basic color PN	KTP600 Basic mono PN	KTP600 Basic color DP	KTP600 Basic color PN
1 x RS 422/RS 485	-	-	-	Max. 12 Mbps	-
1 x Ethernet RJ45	10/100 Mbps			-	10/100 Mbps

**Supply voltage**

	KTP400 Basic mono PN	KTP400 Basic color PN	KTP600 Basic mono PN	KTP600 Basic color DP	KTP600 Basic color PN
Rated voltage	+24 V DC				
Range, permissible	19.2 to 28.8 V (-20%, +20%)				
Transients, maximum permissible	35 V (500 ms)				
Time between two transients, minimum	50 s				
Current consumption					
<ul style="list-style-type: none"> <li>• Typical</li> <li>• Constant current, maximum</li> <li>• Inrush current I<sup>2</sup>t</li> </ul>	Approx. 100 mA Approx. 150 mA Approx. 0.5 A <sup>2</sup> s	Approx. 100 mA Approx. 120 mA Approx. 0.5 A <sup>2</sup> s	Approx. 240 mA Approx. 350 mA Approx. 0.5 A <sup>2</sup> s	Approx. 350 mA Approx. 550 mA Approx. 0.5 A <sup>2</sup> s	
Fuse, internal	Electronic				

**Miscellaneous**

	KTP400 Basic mono PN	KTP600 Basic mono PN	KTP600 Basic color DP	KTP600 Basic color PN
Software clock, synchronizable	Yes			

## 8.4.4 KTP1000 Basic and TP1500 Basic

### HMI device

	KTP1000 Basic color DP	KTP1000 Basic color PN	TP1500 Basic color PN
Weight without packaging	Approx. 2.65 kg		Approx. 4.2 kg

### Display

	KTP1000 Basic color DP	KTP1000 Basic color PN	TP1500 Basic color PN
Type	LCD TFT		
Display area, active	211.2 mm x 158.4 mm (10.4")		304.1 mm x 228.1 mm (15")
Resolution, pixels	640 x 480		1024 x 768
Colors, displayable	256		
Brightness control	Yes		
Pixel error class according to DIN EN ISO 13406-2	II		
Backlighting Half Brightness Life Time (MTBF <sup>1</sup> )	CCFL 50,000 h		

<sup>1</sup> MTBF: Operating hours after which the maximum brightness is reduced by half compared to the original value. MTBF is increased by using the integrated dimming function, for example, time-controlled via screen saver or centrally via PROFlenergy.

### Input device

	KTP1000 Basic color DP	KTP1000 Basic color PN	TP1500 Basic color PN
Type	Touch screen, analog resistive		
Function keys	8 function keys		No
Labeling strips	Yes		No

### Memory

	KTP1000 Basic color DP	KTP1000 Basic color PN	TP1500 Basic color PN
Application memory	1024 KB		

### Interfaces

	KTP1000 Basic color DP	KTP1000 Basic color PN	TP1500 Basic color PN
1 x RS 422/RS 485	Max. 12 Mbps	-	
1 x Ethernet	-		RJ45 10/100 Mbps

8.4 Specifications

Supply voltage

	KTP1000 Basic color DP	KTP1000 Basic color PN	TP1500 Basic color PN
Rated voltage	+24 V DC		
Range, permissible	19.2 to 28.8 V (-20%, +20%)		
Transients, maximum permissible	35 V (500 ms)		
Time between two transients, minimum	50 s		
Current consumption			
<ul style="list-style-type: none"> <li>• Typical</li> <li>• Constant current, maximum</li> <li>• Inrush current <math>I^2t</math></li> </ul>	Approx. 600 mA Approx. 1000 mA Approx. 0.2 A <sup>2</sup> s	Approx. 800 mA Approx. 1000 mA Approx. 0.2 A <sup>2</sup> s	
Fuse, internal	Electronic		

Miscellaneous

	KTP1000 Basic color DP	KTP1000 Basic color PN	TP1500 Basic color PN
Software clock, synchronizable	Yes		



## 8.4.5 Ambient conditions

### 8.4.5.1 Transport and storage conditions

#### Mechanical and climatic conditions for transportation and storage

The transport and storage conditions of this HMI device exceed requirements in accordance with IEC 61131-2. The following specifications apply to the transport and storage of an HMI device in its original packaging.

The climatic conditions conform to the following standards:

- IEC 60721-3-3, Class 3K7 for storage
- IEC 60721-3-2, Class 2K4 for transport

Mechanical requirements conform to EC 60721-3-2, Class 2M2.

Type of condition	Permitted range
Drop test (in transport package)	≤ 1 m
Temperature	From -20 to +60 °C
Atmospheric pressure	From 1080 hPa to 660 hPa, corresponds to an elevation of -1000 to 3500 m
Relative humidity	From 10 % to 90 %, without condensation
Sinusoidal vibration in accordance with IEC 60068-2-6	5 to 8.4 Hz: 3.5 mm 8.4 to 500 Hz: 9.8 m/s <sup>2</sup>
Shock conforming to IEC 60068-2-29	250 m/s <sup>2</sup> , 6 ms, 1000 shocks

NOTICE
<p>Ensure that no condensation (dewing) develops on or inside the HMI device after transporting it at low temperatures or after it has been exposed to extreme temperature fluctuations.</p> <p>The HMI device must have acquired room temperature before it is put into operation. Do not expose the HMI device to direct radiation from a heater in order to warm it up. If dewing has developed, wait approximately 4 hours until the HMI device has dried completely before switching it on.</p>

Proper transport and storage, installation and assembly as well as careful operation and maintenance are required to ensure trouble-free and safe operation of the HMI device.

The warranty for the HMI device will be deemed void if these stipulations are not heeded.

#### See also

Notes about usage (Page 26)

### 8.4.5.2 Conditions of use

#### Mechanical and climatic conditions of use

The HMI device is designed for use in a location protected from the effects of the weather. The conditions of use are compliant with requirements to DIN IEC 60721-3-3:

- Class 3M3 (mechanical requirements)
- Class 3K3 (climatic requirements)

#### Use with additional measures

The HMI device should not be used at the following locations unless additional measures are taken:

- In locations with a high degree of ionizing radiation
- In locations with difficult operating conditions - for example due to:
  - Corrosive vapors, gases, oils or chemicals
  - Electrical or magnetic fields of high intensity
- In plants that require special monitoring - for example:
  - Elevators
  - Systems in especially hazardous rooms

#### Mechanical ambient conditions

The mechanical ambient conditions for the HMI device are specified in the following table in terms of sinusoidal vibration.

Frequency range in Hz	Constant	Occasional
$10 \leq f \leq 58$	Amplitude 0.0375 mm	Amplitude 0.075 mm
$58 \leq f \leq 150$	Constant acceleration 0.5 g	Constant acceleration 1 g

#### Reducing vibrations

If the HMI device is subjected to greater shocks or vibrations, you must take appropriate measures to reduce acceleration or amplitudes.

We recommend fitting the HMI device to vibration-absorbent material (on metal shock absorbers, for example).

### Testing mechanical ambient conditions

The following table provides information on the type and scope of tests for mechanical ambient conditions.

Tested for	Test standard	Comments
Vibrations	Vibration test in accordance with IEC 60068, part 2-6 (sinusoidal)	Type of vibration: Transitional rate of the frequency: 1 octave/minute. 10 Hz ≤ f ≤ 58 Hz, constant amplitude of 0.075 mm 58 Hz ≤ f ≤ 150 Hz, constant acceleration 1 g Vibration duration: 10 frequency cycles per axis at each of the three associated vertical axes
Shock	Shock test in accordance with IEC 60068, Part 2 -27	Type of shock: Half-sine Shock intensity: Peak value 15 g, duration 11 ms Direction of impact: 3 shocks in ± direction at each one of the three associated vertical axes

### Climatic ambient conditions

The following table shows the climatic ambient conditions for operation of the HMI device.

Ambient conditions	Permitted range	Comments
Temperature <ul style="list-style-type: none"> <li>• Vertical mounting</li> <li>• Mounting at an angle</li> </ul>	From 0 to 50° C From 0 to 40° C	Slope angle max. 35°
Relative humidity	10 to 90 %, without condensation	
Atmospheric pressure	1080 to 795 hPa	Corresponds to an elevation of – 1,000 to 2,000 m
Pollutant concentration	SO <sub>2</sub> : < 0.5 ppm; Relative humidity < 60%, no condensation	Test: 10 cm <sup>3</sup> /m <sup>3</sup> ; 10 days
	H <sub>2</sub> S: < 0.1 ppm; Relative humidity < 60%, no condensation	Test: 1 cm <sup>3</sup> /m <sup>3</sup> ; 10 days

### 8.4.5.3 Information on insulation tests, protection class and degree of protection

#### Test voltages

Insulation strength is demonstrated in the type test with the following test voltages in accordance with IEC 61131-2:

Circuits with a nominal voltage of $U_n$ to other circuits or ground	Test voltage
< 50 V	500 VDC

#### Protection class

Protection Class I in accordance with IEC 60536, i.e. PE/ground terminal to profile rail required!

#### Protection against foreign objects and water

Degree of protection in accordance with IEC 60529	Explanation
Front	When mounted: <ul style="list-style-type: none"><li>• IP65</li><li>• Front face only Type 4X/Type 12 (indoor use only)</li></ul>
Rear panel	IP20 Touch protection test with standard test probes. There is no protection against ingress by water.

The degree of protection at the front can only be guaranteed if the mounting seal is installed flush to the mounting cut-out. Read the corresponding information in section "Making the mounting cut-out".

#### See also

Making the mounting cut-out (Page 31)

## 8.5 Interface description

### 8.5.1 Power supply

Plug connector, 2-pin



Pin number	Assignment
1	+24 VDC (L+)
2	GND 24 V (M)

### 8.5.2 PROFIBUS (Sub-D RS422/485)

Name of interface on HMI device: X2

Sub-D socket, 9-pin, with screw lock

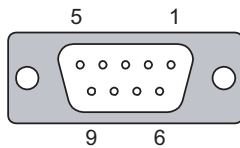

Pin	Assignment for the RS 422	Assignment for the RS 485
1	n. c.	n. c.
2	GND 24 V	GND 24 V
3	TxD+	Data channel B (+)
4	RD+	RTS
5	GND 5 V, floating	GND 5 V, floating
6	+5 VDC, floating	+5 VDC, floating
7	+24 VDC, out (max. 100 mA)	+24 VDC, out (max. 100 mA)
8	TxD-	Data channel A (-)
9	RxD-	NC

### 8.5.3 PROFINET (Ethernet)

Name of interface on HMI device: X1

RJ45 plug connector

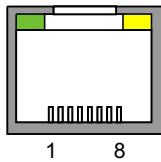

Pin	Assignment
1	Tx+
2	Tx-
3	Rx+
4	n. c.
5	n. c.
6	Rx-
7	n. c.
8	n. c.

#### Meaning of LEDs

State	Green "SPEED" LED	Yellow "LINK" LED
No connection	On <sup>1</sup>	Off
10 MB connection	Off	On
100 MB connection	On	On
Active data transfer 10 MB	Off	Flashing
Active data transfer 100 MB	On	Flashing

<sup>1</sup> For KTP1000 Basic and TP1500 Basic: Off

## 8.6 Functional scope with WinCC flexible and WinCC

The following tables show the objects that can be integrated in a project for a Basic Panel.

### Alarms

Object	Specification	Basic Panels
Alarms	Number of discrete alarms	200
	Number of analog alarms	15
	Length of the alarm text	80 characters
	Number of tags in an alarm	Max. 8
	<i>Display</i>	<i>Alarm window, alarm view</i>
	<i>Acknowledge error alarm individually</i>	<i>Yes</i>
	<i>Acknowledge multiple error alarms simultaneously (group acknowledgement)</i>	<i>16 acknowledgment groups</i>
	<i>Edit alarm</i>	<i>Yes</i>
Alarm buffer	<i>Alarm indicator</i>	<i>Yes</i>
	Alarm buffer capacity	256 alarms
	Simultaneously queued alarm events	Max. 64
	<i>View alarm</i>	<i>Yes</i>
	<i>Delete alarm buffer</i>	<i>Yes</i>

### Tags, values and lists

Object	Specification	KP300 Basic mono PN KTP400 Basic mono PN	KP400 Basic color PN KTP400 Basic color PN KTP600 Basic mono PN KTP600 Basic color DP/PN KTP1000 Basic color DP/PN TP1500 Basic color PN
Tags	Quantity	250	500
<i>Limit value monitoring</i>	<i>Input/output</i>		<i>Yes</i>
<i>Linear scaling</i>	<i>Input/output</i>		<i>Yes</i>
Text lists	Quantity		150

### Screens

Object	Specification	Basic Panels
Screens	Quantity	50
	Fields per screen	30
	Tags per screen	30
	Complex objects per screen (for example, bars)	5
	Template	Yes

## Recipes

The specified values are maximum values and should not be used additive.

Object	Specification	Basic Panels
Recipes	Quantity	5
	Elements per recipe	20
	Data records per recipe	20

## Safety

Object	Specification	Basic Panels
Safety	Number of user groups	50
	Number of users	50
	Number of authorizations	32

## Infotexts

Object	Specification	Basic Panels
Infotexts	Length (no. of characters)	320
	For alarms	Yes
	For screens	Yes
	For screen objects (for example, for I/O field, switch, button, invisible button)	Yes

## Additional functions

Object	Specification	Basic Panels mono	Basic Panels color
Screen settings	Touch screen calibration	Yes <sup>1</sup>	Yes <sup>1</sup>
	Brightness setting	-	Yes <sup>2</sup>
	Contrast setting	Yes	-
Language change	Number of languages	5	
Graphic objects	Vector and pixel graphics	Yes	
Trend views	Quantity	max. 25	
Trends per view	Quantity	max. 4	
Text objects	Quantity	500	

<sup>1</sup> Not KP300 Basic mono PN and KP400 Basic color PN

<sup>2</sup> Not KTP600 Basic mono PN, KTP600 Basic color PN, KTP600 Basic color DP



## New system functions

In addition to the system functions already available, WinCC flexible 2008 SP2 and WinCC V11 or higher support the following system functions for the Basic Panels:

System function/syntax	Application
SetBitInTag (Tag, Bit)	Sets a bit in the specified tag to 1 (TRUE).
ReSetBitInTag (Tag, Bit)	Sets a bit in the specified tag to 0 (FALSE).
InvertBitInTag (Tag, Bit)	Inverts a bit in the specified tag.
SetColorBackgroundLighting (value) <sup>1)</sup>	Specifies the color for the backlighting.

<sup>1</sup> KP300 Basic mono PN only

For more information, refer to "System functions" in the the Online Help of WinCC flexible and WinCC.



# Technical Support

## A.1 Service and support

You can find additional information and support for the products described on the Internet at the following addresses:

- Technical support  
([http://www.siemens.de/automation/csi\\_en\\_WW](http://www.siemens.de/automation/csi_en_WW))
- Support request form  
(<http://www.siemens.com/automation/support-request>)
- After-sales information system for SIMATIC PC / PG  
(<http://www.siemens.com/asis>)
- SIMATIC Documentation Collection  
(<http://www.siemens.com/simatic-tech-doku-portal>)
- Your local representative  
(<http://www.automation.siemens.com/mcms/aspa-db/en/Pages/default.aspx>)
- Training center  
(<http://sitrain.automation.siemens.com/sitrainworld/?AppLang=en>)
- Industry Mall  
(<http://mall.automation.siemens.com>)

When contacting your local representative or Technical Support, please have the following information at hand:

- Order number of the device (MLFB)
- BIOS version (industry PC) or image version (HMI device)
- Installed additional hardware
- Installed additional software

## Tools & downloads

Please check regularly if updates and hotfixes are available for download to your device. The downloads are available on the Internet under "After Sales Information System SIMATIC PC/PG" (see above).

## A.2 System events

System events on the HMI device provide information about internal states of the HMI device and PLC.

---

### Note

System events are only indicated if an alarm window was configured. System events are output in the language currently set on your HMI device.

---

### System event parameters

System events may contain encrypted parameters which are relevant to troubleshooting because they provide a reference to the source code of the runtime software. These parameters are output after the text "Error code:"

### Description of the system events

A listing of all system alarms for your HMI device is provided in the Online Help of your configuration software.

# B

## Abbreviations

ANSI	American National Standards Institution
CPU	Central Processing Unit
CSV	Comma Separated Values
CTS	Clear To Send
DC	Direct Current
DCD	Data Carrier Detect
DHCP	Dynamic Host Configuration Protocol
DIL	Dual-in-Line (electronic chip housing design)
DNS	Domain Name System
DP	Distributed I/O
DSN	Data Source Name
DSR	Data Set Ready
DTR	Data Terminal Ready
IO	Input and Output
ESD	Components and modules endangered by electrostatic discharge
EMC	Electromagnetic Compatibility
EN	European standard
ES	Engineering System
ESD	Components and modules endangered by electrostatic discharge
GND	Ground
HF	High Frequency
HMI	Human Machine Interface
IEC	International Electronic Commission
IF	Interface
IP	Internet Protocol
LED	Light Emitting Diode
MAC	Media Access Control
MOS	Metal Oxide Semiconductor
MPI	Multipoint Interface (SIMATIC S7)
MS	Microsoft
MTBF	Mean Time Between Failures
n. c.	Not connected
NTP	Network Time Protocol
OP	Operator Panel
PC	Personal Computer
PG	Programming device
PPI	Point-to-Point Interface (SIMATIC S7)
RAM	Random Access Memory

PELV	Protective Extra Low Voltage
RJ45	Registered Jack Type 45
RTS	Request to send
RxD	Receive Data
SD Card	Security Digital Card
SELV	Safety Extra Low Voltage
SP	Service Pack
PLC	Programmable Logic Controller
STN	Super Twisted Nematic
Sub-D	Subminiature D (plug)
TAB	Tabulator
TCP/IP	Transmission Control Protocol/Internet Protocol
TFT	Thin Film Transistor
TTY	Teletype
TxD	Transmit Data
UL	Underwriter's Laboratory
USB	Universal Serial Bus
UPS	Uninterruptible power supply
WINS	Windows Internet Naming Service

# Glossary

## **"Transfer" mode**

HMI device operating mode for transferring an executable project from the configuring PC to an HMI device.

## **Acknowledge**

Acknowledgment of an alarm confirms that it has been noted.

## **Alarm, acknowledgment**

Acknowledgment of an alarm confirms that it has been noted.

## **Alarm, activated**

Moment at which an alarm is triggered by the PLC or HMI device.

## **Alarm, deactivated**

Moment at which the initiation of an alarm is reset by the PLC.

## **Alarm, user-specific**

User-specific alarms report specific states of a plant that is interconnected with the HMI device via the PLC.

## **Automation system**

An automation system is a PLC of the SIMATIC S7 product line, e.g. SIMATIC S7-300

## **Boot loader**

The boot loader is used to start the operating system and is started automatically after power on of the HMI device. The Loader is displayed after the operating system has loaded.

## **Configuration software**

The configuration software is used to create projects for process visualization. WinCC flexible is such a configuration software, for example.

### **Configuring PC**

A configuring PC is a programming device or PC on which plant projects are created using an engineering software.

### **Display duration**

Defines whether a system alarm is displayed on the HMI device and the duration of the display.

### **EMC**

Electromagnetic compatibility is the ability of electrical equipment to function properly in its electromagnetic environment without influencing this environment.

### **Event**

Incoming events trigger defined functions. Events can be configured. Events which can be assigned to a button include "Press" and "Release", for example.

### **Field**

Area reserved in configured screens for the input and output of values.

### **Flash memory**

Flash memory is a non-volatile memory with EEPROM chips that is implemented either as mobile storage medium, or as permanently installed memory module on the motherboard.

### **Function key**

Function keys on the HMI device can be assigned user-specific functions. The functions assigned to those keys are defined in the engineering phase. The function key assignment can be specific to an active screen or not.

### **Half Brightness Life Time**

Time period after which brightness is reduced to 50% of the original value. The specified value depends on the operating temperature.

### **HMI device**

HMI devices are used to operate and monitor machinery and plants. The machine or plant states are visualized on the HMI device by means of graphic objects or signal lamps. The operator controls of the HMI device enable intervention in machine or plant processes and sequences.



**HMI device image**

The HMI device image is a file that can be transferred from the configuring PC to the HMI device. The HMI device image contains the operating system of the HMI device, including the elements of the Runtime software required for the executable project file.

**I/O field**

Enables the input or output of values on the HMI device and their transfer to the PLC.

**Infotext**

A configured infotext provides information about objects within a project. An alarm infotext, for example, can contain information on the cause and troubleshooting of faults.

**Object**

An object is a project element such as a screen or an alarm. Objects are used to view or enter texts and values on the HMI device.

**Operating element**

An operating element is a project component that is used to enter values and trigger functions. A button is such an operating element.

**Plant**

General term referring to machinery, processing centers, systems, plants and processes which are operated and monitored using an HMI device.

**PLC**

PLC is a general term for devices and systems with which the HMI device communicates, e.g. SIMATIC S7.

**PLC job**

A PLC job triggers a function at the HMI device.

**Process visualization**

Denotes visualization of technical processes by means of text and graphic elements. Configured plant screens enable intervention in runtime plant processes by means of data input and output.

## Project

A project is the result of a configuration using an engineering software. The project usually contains several screens with embedded system-specific objects, basic settings and alarms. A project configured in WinCC flexible is saved to a project file with the extension \*.hmi.

There is a difference between an offline project on a configuring PC and an online executable project on an HMI device. A project can be available in more languages on the configuring PC than can be managed on the HMI device. The project on the configuring PC can also be set up for different HMI devices. However, on the HMI device you can only transfer the executable project that has been generated specifically for this HMI device.

## Project file

Source file from which the executable project file for the HMI device is generated. The project file is usually not transferred and is retained on the configuring PC.

## Project file, compressed

Compressed format of the project file. The compressed project file can be transferred in addition to the executable project file to the corresponding HMI device. The upload function must be activated accordingly on the configuring PC at the time of the transfer. The compressed project file is usually saved to an external memory card.

A compressed project file has the extension \*.pdz.

## Project file, executable

An executable project file is generated from the project file for a specific HMI device in the course of engineering. The executable project file is transferred to the associated HMI device where it is used to operate and monitor plants.

## ProSave

ProSave provides all functions necessary to transfer data between the configuring PC and the HMI device. For example, saving and restoring data or managing license keys and add-ons.

ProSave is installed by default together with WinCC flexible or WinCC. The standalone version of ProSave can also be used for service purposes on a PC without WinCC flexible installation. The standalone version is available on the installation DVD of WinCC flexible.

## Recipe

A recipe represent a combination of tags that form a fixed data structure. The configured data structure can be assigned data in the configuration software or on the HMI device and is then referred to as a data record. The use of recipes ensures that all data assigned to a data record is transferred synchronously to the PLC.

**Runtime software**

The Runtime software is a process visualization software which can be used to test projects on a configuring PC.

**Screen**

Mode of visualization of all logically associated process data of a plant. Visualization of the process data can be supported by means of graphic objects.

**Screen object**

Refers to objects such as rectangles, I/O fields, or alarm views which are configured for visualization or operation of the plant.

**STEP 7**

STEP 7 is the programming software for SIMATIC S7, SIMATIC C7 and SIMATIC WinAC PLCs.

**STEP 7 Micro/WIN**

STEP 7 Micro/WIN is the programming software for SIMATIC S7-200 PLCs.

**Symbolic I/O field**

Symbolic I/O fields are used for the input and output of values. A field contains a list of default entries from which one can be selected.

**System alarms**

System alarms are assigned the "System" alarm class. A system alarm reports internal states of the HMI device and of the PLC.

**Tab order**

The tab order defined in the course of project engineering determines the sequence for activating objects by pressing the <TAB> key.

**Tags**

A tag is a defined memory area that is used to read and write values. Those tags can be accessed from the PLC or using the HMI device. We distinguish between external tags (process tags) and internal tags, depending on whether or not the tag is interconnected with the PLC.

## **Transfer**

Transfer of an executable project from the configuring PC to the HMI device.

## **WinCC**

WinCC (TIA Portal) is engineering software for configuring SIMATIC Panels, SIMATIC Industrial PC and standard PC with the visualization software WinCC Runtime Advanced or the SCADA system, WinCC Runtime Professional.

A project created with WinCC has the file extension "\*.ap11". An executable project file on a HMI device has the extension "\*.fwx".

## **WinCC flexible**

WinCC flexible is an engineering software for configuring SIMATIC Panels, SIMATIC Industrial PC and Standard PC in machine-related areas with the visualization software WinCC flexible Runtime.

A project created with WinCC flexible has the file extension "\*.hmi". An executable project file on a HMI device has the extension "\*.fwx".

# Index

## A

- ACK key, 65
- Acknowledge key, 65
- Activating
  - Automatic transfer, 84
- Ambient conditions
  - Climatic, 139
  - Mechanical, 138
  - Test, 139
- Approval for Australia, 117
- Approvals, 117
- Automatic transfer
  - Activating, 84

## B

- Backspace key, 64
- Backup, 91, 96, 97, 99
  - Data of the HMI device, 100
  - With ProSave, 99
  - with WinCC, 100
  - With WinCC flexible, 97
- Basic knowledge
  - Required, 4

## C

- Cancel key, 64
- Care, 115
- CE approval, 117
- Checking
  - Conditions of use, 138
  - Electromagnetic Compatibility, 118
  - Package content, 29
  - Standards and approvals, 117
  - Transport and storage conditions, 137
- Clamping frame, 23
- Climatic
  - Storage conditions, 137
  - Transport conditions, 137

## Clock

- KP300 Basic, 132
- KTP1000 Basic, TP1500 Basic, 136
- KTP400 Basic, KTP600 Basic, 134
- Commissioning engineers, 3
- Compatibility conflict, 96
- Components sensitive to electrostatic charge, 119
- Conductor cross-section
  - Equipotential bonding, 38
- Configuration phase, 89
- Configuring
  - MPI/Profibus Settings, 69
  - Network settings, 70
  - RS422/RS485 port, 46
  - Time server, 71, 86
- Configuring PC, 89
- Connecting
  - Configuring PC, 42
  - Equipotential bonding, 38
  - PLC, 45
  - Power supply, 40
  - Programming device, 41
- Control cabinet
  - Working on, 25
- Control Panel
  - Menu structure, 81
  - Opening, 67
  - Overview, 68, 81
  - Password protection, 68, 80
- Cursor key, 64

## D

- Data channel
  - Enabling, 84
  - Locking, 84
- Decimal places, 56, 58, 63
- Degree of protection
  - Protection against ingress of solid foreign bodies, 140
  - Protection against water, 140
- Delete key, 64
- DIP switch
  - Setting, 46

Display  
  KP300 Basic, 131  
  KTP1000 Basic, TP1500 Basic, 135  
  KTP400 Basic, KTP600 Basic, 133

Disposal, 116

Disturbance  
  Pulse-shaped, 118  
  Sinusoidal, 119

## E

EC Declaration of Conformity, 117  
Elbow adapter, 23  
Electrical isolation, 131  
Electrical potential difference, 38  
EMC directive, 117  
Emission, 26, 119  
Enabling  
  Data channel, 84  
Enabling a data channel, 68  
END key, 64  
Enter key, 64  
ENTER key, 64  
Equipotential bonding  
  Cable, 38  
  Connecting, 38  
  Requirements, 38  
  Wiring diagram, 39  
ESC key, 64  
ESD, 119  
ESD guidelines, 119

## F

Factory setting  
  With ProSave, 112  
  with WinCC, 114  
  With WinCC flexible, 110  
Figures, 5

Functional scope  
  Alarm buffer, 143  
  Alarms, 143  
  Graphic objects, 144  
  Infotext, 144  
  Language change, 144  
  Limit value monitoring, 143  
  Recipes, 144  
  Safety, 144  
  Scaling, 143  
  Screen settings, 144  
  Screens, 143  
  Tags, 143  
  Text lists, 143  
  Text objects, 144  
  Trend views, 144

## G

Guidelines  
  ESD guidelines, 119

## H

High frequency radiation, 25  
HMI device  
  Connecting, 36  
  Data backup, 100  
  EMC-compatible installation, 118  
  Mounting, 34  
  Restoring data, 101  
  Shutting down, 49  
  Switching on, 48  
  Technical specifications, 131, 133, 135  
  Testing, 48  
  Updating the operating system, 109  
HOME key, 64

## I

Illustrations, 5  
Infotext  
  Key, 65  
Initial startup, 89  
Input device  
  KP300 Basic, 132  
  KTP1000 Basic, TP1500 Basic, 135  
  KTP400 Basic, KTP600 Basic, 133  
Installation as intended, 25  
Insulation test, 140

## Interfaces

- KP300 Basic, 132
- KTP1000 Basic, TP1500 Basic, 135
- KTP400 Basic, KTP600 Basic, 134

IT Security, 26

**K**

## Key

- ACK, 65
- Cancel, 64
- Cursor, 64
- Delete, 64
- END, 64
- ENTER, 64
- ESC, 64
- HOME, 64
- Infotext, 65
- Scroll back, 64
- Scroll forward, 64
- SHIFT, 64
- Switching, 64

**L**

## Labeling

- Approvals, 117
- EC Declaration of Conformity, 117

Limit value check, 56, 58, 62

List of abbreviations, 149

## Locking

- Data channel, 84

**M**

Maintenance, 115

Maintenance technicians, 3

## Mechanical

- Ambient conditions, 138
- Storage conditions, 137
- Transport conditions, 137

## Memory

- KP300 Basic, 132
- KTP1000 Basic, TP1500 Basic, 135
- KTP400 Basic, KTP600 Basic, 133

## Mounting

- EMC-compatible, 118
- HMI device, 34

## Mounting clamp

- Aluminum, 35
- Plastic, 36

MPI/Profibus Settings, 68

**N**

Non-isolated plant configuration, 131

**O**

## Offline

- Operating mode, 90
- Test, 95

## Online

- Operating mode, 90
- Test, 96

## OP properties

- Device, 68
- Display, 68
- License, 68
- Touch, 68

## Operating

- Control Panel with system keys, 65
- Dialog with system keys, 65
- Keyboard unit, 63
- Project with system keys, 65

## Operating instructions

- Purpose of, 3
- Scope, conventions, 4

## Operating mode, 90

- Changing, 90
- Offline, 90
- Online, 90
- Transfer, 90

## Operating system

- Update using ProSave, 104, 108
- Update using WinCC flexible, 103
- Updating, 101, 105
- Updating using WinCC flexible, 107

Operators, 3

- P**
- Package content
    - Checking, 29
  - Password properties, 68
  - Password protection, 68, 80
    - Activating, 78, 87
    - Deactivating, 78, 87
  - PELV, 131
  - Plant configuration
    - Non-isolated, 131
  - PLC
    - Configuring the interface, 46
  - Power failure, 96
  - Process control phase, 89
  - PROFIBUS connector, 23
  - PROFINET connector, 23
  - Profinet Settings, 68
  - Project
    - Offline testing, 95
    - Testing online, 96
    - Transferring, 89
  - Protection class, 140
  - Protective foil, 24
  - Protective measure
    - Static electricity, 121
- R**
- Radiation
    - High frequency, 25
  - Radio interference, 26
    - Emission, 119
  - Rated voltage, 131
  - Recommissioning, 89
  - Recycling, 116
  - Registered trademarks, 6
  - Regulations for the prevention of accidents, 25
  - Restore, 91, 96, 100
    - With ProSave, 100
  - Restoring, 98
    - Data of the HMI device, 101
      - with WinCC, 101
      - With WinCC flexible, 98
  - Restoring data
    - HMI device, 101
  - RS 422 to RS 232 converter, 23
  - RS422/RS485 port
    - Configuring, 46
- S**
- Safe electrical isolation, 131
  - Safety
    - Standards, 117
  - Safety instruction
    - Compatibility conflict, 96
    - Data channel, 102, 106
    - Data loss, 101, 105
    - Equipotential bonding cable, 38
    - General, 26
    - High frequency radiation, 25
    - Operation indoors, 26
    - Power failure, 96
    - Preventing inadvertent operation, 115
    - Storage, 137
    - Transport, 137
    - unauthorized cleaning products, 115
    - Unintentional response, 115
    - Working on the control cabinet, 25
  - Safety regulations, 25
  - Screen keyboard
    - Alphanumerical, 55, 57
    - Key assignment, 55, 57
    - KTP400 Basic, 54
    - KTP600 Basic, KTP1000 Basic, TP1500 Basic, 57
    - Numerical, 56, 58
  - Screen saver, 68
  - Screen settings
    - Editing, 68
  - Scroll back key, 64
  - Scroll forward key, 64
  - Securing device
    - with aluminum mounting clamps, 35
    - with plastic mounting clamps, 36
  - Security information, 26
  - Service packages, 24
  - Service technicians, 3
  - Shift key, 64
  - SHIFT key, 64
  - Shutting down
    - HMI device, 49
  - Sound Settings, 68
  - Spare part
    - Plastic clamp, 24
    - Power supply terminal, 24
  - Static electricity
    - Protective measures, 121



- Storage conditions, 137
- Strain relief, 50
- Stripping, 39
- Supply voltage
  - KP300 Basic, 132
  - KTP1000 Basic, TP1500 Basic, 136
  - KTP400 Basic, KTP600 Basic, 134
- Switching on
  - HMI device, 48
- System events
  - in the online help, 148
  - Parameters, 148
- System keys
  - Operating a dialog, 65
  - Operating a project, 65
  - Operating the Control Panel, 65

## T

- Technical specifications
  - Display, 131, 133, 135
  - Input device, 132, 133, 135
  - Interfaces, 132, 134, 135
  - Memory, 132, 133, 135
  - Supply voltage, 132, 134, 136
- Test
  - Power supply, 131
- Testing
  - HMI device, 48
- Time server
  - Configuring, 86
- Time Server Configuration, 68
- Trademarks, 6
- Transfer, 89, 90, 91
  - Automatic, 93
  - Manual, 91
- Transfer settings, 68
- Transferring
  - Project, 89
- Transport conditions, 137

## U

- UL approval, 117
- Update
  - Using WinCC flexible, 103
- Updating
  - Operating system, 101, 105
  - Operating system of the HMI device, 109
  - Using ProSave, 104, 108
  - Using WinCC flexible, 107
  - with WinCC, 109
- Usage
  - Conditions, 138
  - With additional measures, 138
- USB/PPI cable, 23
- Use
  - In residential areas, 26
  - Industrial, 26

## V

- Vibrations, 138

## W

- Weight
  - KP300 Basic, 131
  - KTP1000 Basic, TP1500 Basic, 135
  - KTP400 Basic, KTP600 Basic, 133
- Working on the control cabinet, 25

